



IN-LINE MIXED FLOW DUCT FANS

MIXVENT-TD Fan Systems



MIXVENT TD / MIXVENT TD-T

Description

The MIXVENT system has been designed to compliment the MIXVENT-TD range of in-line fans. All MIXVENT -TD fans include the combination of a powerful motor factory matched to a mixed flow impeller. This motor and impeller combination enables the MIXVENT-TD fans to deliver high airflow performances with the minimum of noise generation against high static pressures typically found in ducted ventilation systems.

The unique design of the MIXVENT TD and TDx2 support brackets, allows the motor and

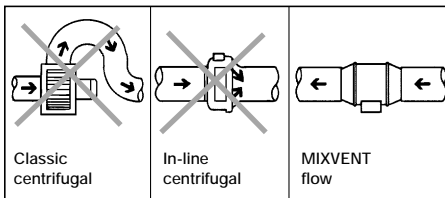

impeller assembly to be fitted or removed without dismantling the adjacent ducting and therefore facilitating any installation or maintenance.

The internal aerodynamic design of MIXVENT-TD fan enables the unit to generate large air volumes and pressures with the minimum of in-duct or radiated noise.

An additional advantage of the MIXVENT TD fans is that they are fitted with direct connection two speed motors as standard. In addition, all motors are suitable for speed control regulation using electronic or auto-transformer controllers. The MIXVENT-TD fans offer the ideal in-line duct fan solution for a wide range of HVAC ventilation applications.



MIXVENT TDx2

Range

The MIXVENT system includes 3 ranges of products:

- MIXVENT TD, Single Fan Unit
- MIXVENT TDx2, Twin Fan Unit
- MIXVENT TD-T, Twin Fan Unit with Overrun Timer

The **MIXVENT-TD** consists of eight (8) nominal sized in-line fans. All models are specifically designed for direct connection in-line with industry standard diameter circular ducting.

The **MIXVENT-TDx2** range consists of two MIXVENT TD fans mounted in series to produce almost twice the pressure of a single TD fan. The range consists of 5 nominal fan diameter sizes.

The **MIXVENT-TD-T** consists of a range of five (5) nominal size TD fans (160, 250, 350, 500 and 800) fitted with an Run-On-Timer adjustable between 1 to 30 minutes. (The MIXVENT TD-T range is not suitable for speed control.)

Accessories

The MIXVENT System includes a specific range of accessories enabling the installation of different combinations of the MIXVENT TD and MIXVENT TDx2 fans, using models 350, 500, 800 and 1000.

These combinations include:

MIXVENT Twin

Two MIXVENT TD fans mounted in parallel using the Twin Base Kit. Mounting the fans in parallel produces double the duty of one fan (at the same pressure).

MIXVENT Twin x 2

Two MIXVENT TDx2 fans mounted in parallel using the Twin Base Kit.

Mounting the fans in parallel produces double the duty of a single TDx2fan (at the same pressure).

MIXVENT Twin x 3

MIXVENT-TD and MIXVENT TDx2 mounted in series using the Flange (MBR). The pressure achieved by this arrangement will produce almost three times that of a single unit (at the same air volume).

To compliment the MIXVENT System a range of electrical and additional mechanical accessories are available to complete the most demanding installations.



ACCESSORIES

Construction

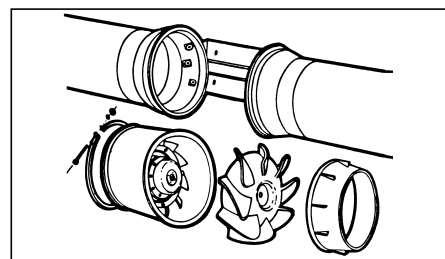

The MIXVENT TD models are manufactured in tough reinforced plastic, except models 160, 1000, 1300 & 2000 which have a metal casing and are finished in a tough epoxy-polyester paint coating.

The TD fan duct connection flanges are manufactured from reinforced plastic, except for models 800, 1000, 1300 & 2000 which are constructed from epoxy-polyester coated metal.

Impellers

The impeller blades are moulded in tough ABS plastic except models 800N, 1000, 1300 and 2000 which are in metal.

Motors

Models 160, 250 and 350:

- Single-phase, 230V 50Hz, shaded pole induction asynchronous motor in die cast aluminium. All motors include direct two speed connection and are also suitable for voltage speed control*. Manufactured in accordance to standards UNE 20-113 and CEI 34-1.
- Class II electrical insulation (model 160) and Class I (models 250 and 350)
- IP 44 Protection
- Class B Motor Insulation
- Safety Thermal Overload Protection (fuse type)
- Self-lubricating sleeve bearings.

Models 500, 800, 1000, 1300 and 2000:

- Single-phase induction asynchronous motor, with permanent capacitor and external rotor in die cast aluminium. All models include direct two speed connection and are also suitable for voltage speed control*. Manufactured in accordance with standards UNE 20-113 and CEI 34-1.
- Class I electrical insulation.
- IP 44 Protection
- Class B Motor Insulation
- Thermal Overload Protection
- Sealed For Life, ball bearings

*Except TD-T models.



MIXVENT-TD / MIXVENT TDx2



Model Reference

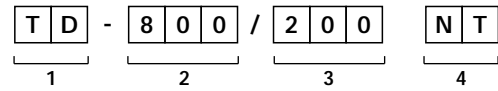

- 1 Series reference
- 2 MIXVENT TD model type (Nom. max. m³/hr)
- 3 Nominal ducting connection diameter (mm)
- 4 Type where applicable

Technical characteristics

Model Type	Nom. speed (r.p.m.)	Maximum absorbed power at 0Pa (W)	Maximum absorbed current (A)	Duty at free discharge (m ³ /h)	Maximum operating temperature (°C)	Sound pressure level* (dB(A))	Weight (kg)
TD-160/100N	2500 2100	35 23	0,25 0,15	160 130	40 40	18 14	1,4
TD-250/100	1880 1475	39 26	0,26 0,18	250 185	40 40	28 23	2,0
TD-350/125	2210 1900	56 40	0,37 0,26	360 300	40 40	30 26	2,0
TD-500/ ¹⁵⁰ / ₁₆₀	2500 1850	68 50	0,30 0,22	535 400	60 60	41 33	2,7
TD-800/200N	2700 2100	80 70	0,35 0,30	907 700	60 60	41 36	4,9
TD-800/200	2450 2040	128 96	0,55 0,41	880 665	60 60	45 37	4,9
TD-1000/250	2800 2100	155 85	0,65 0,39	1010 850	60 60	49 43	9,4
TD-1300/250	2520 1990	170 110	0,72 0,48	1300 950	60 60	49 44	9,4
TD-2000/315	2760	350 200	1,30 0,90	1990 1510	60 60	52 50	14,0

* Radiated sound level measured at 3 m from product casing at free air conditions.

MIXVENT-TD



Reference

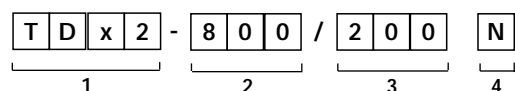

- 1 Series reference
- 2 MIXVENT TD model type (Nom. max. m³/h)
- 3 Nominal ducting connection diameter (mm)
- 4 Type where applicable

Technical characteristics

Model Type	Nom. speed (r.p.m.)	Maximum absorbed power at 0Pa. (W)	Maximum absorbed current (A)	Duty at free discharge (m ³ /h)	Maximum operating temp. (°C)	Sound pressure level* (dB(A))	Weight (kg)
TDx2-350/125	2630 2200	150 90	1,12 0,58	395 320	40 40	36 31	5,4
TDx2-500/ ¹⁵⁰ / ₁₆₀	2720 2300	140 100	0,60 0,44	510 415	60 60	48 41	5,0
TDx2-800/200N	2800 2450	165 140	0,72 0,60	900 690	60 60	48 44	8,7
TDx2-800/200	2700 2400	280 180	1,20 1,10	875 705	60 60	52 48	8,7
TDx2-1000/250	2800 2100	300 170	1,30 0,78	1020 850	60 60	57 51	18,7
TDx2-1300/250	2520 1990	340 220	1,44 0,96	1320 980	60 60	57 52	18,7

* Radiated sound level measured at 3 m from ducting product at free air conditions.

In-Line Duct Fans



MIXVENT TD

■ Performance curves

- Q = Air volume in, m³/hr and m³/s
- Pe = Static pressure in mmWG and Pa.
- Dry air at 20 °C and 760 mmHg.

HS = High speed
LS = Low speed

- Air flow data in accordance with the following standards: UNE 100-212-89, BS 848, Part 1, AMCA 210-85 and ASHRAE 51-1985.

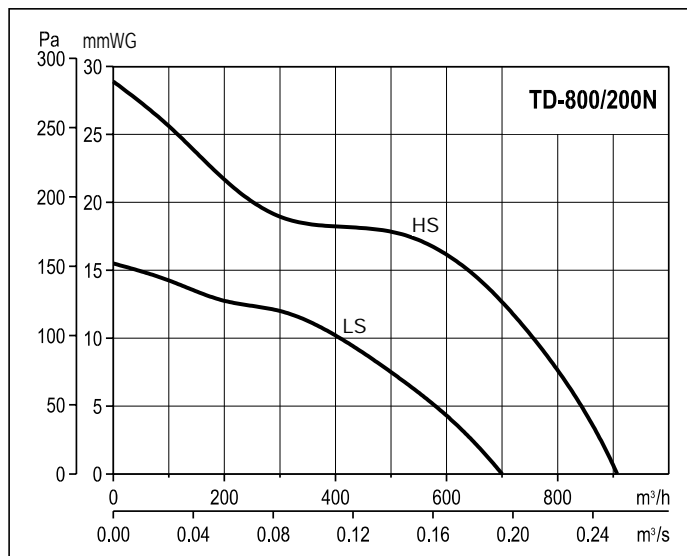
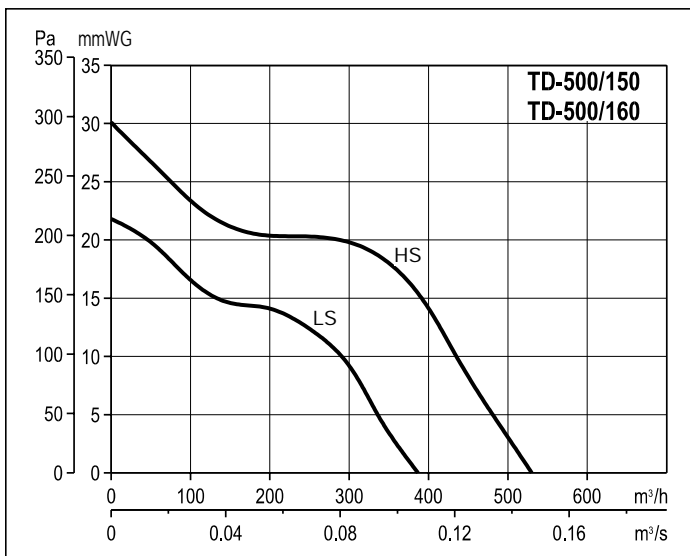
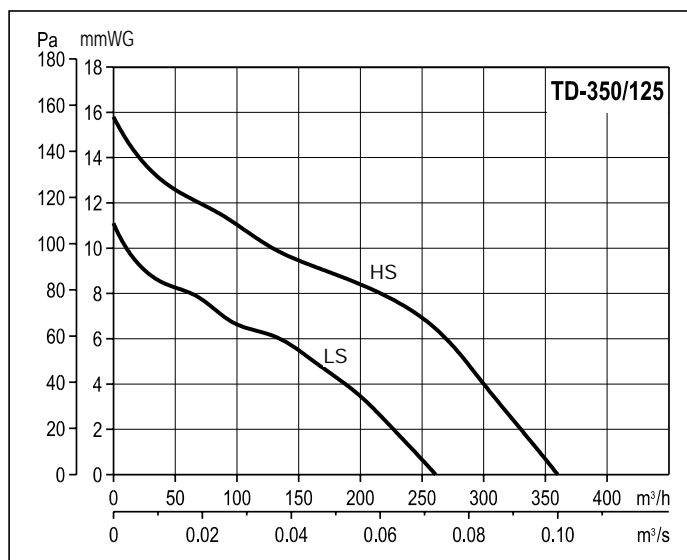
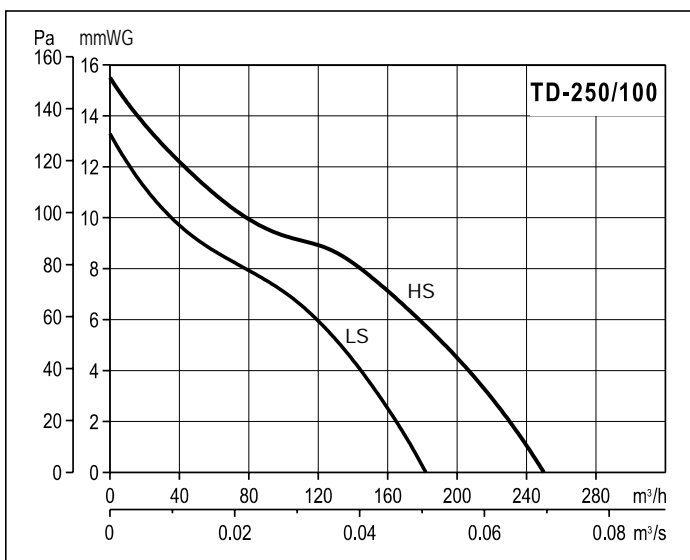
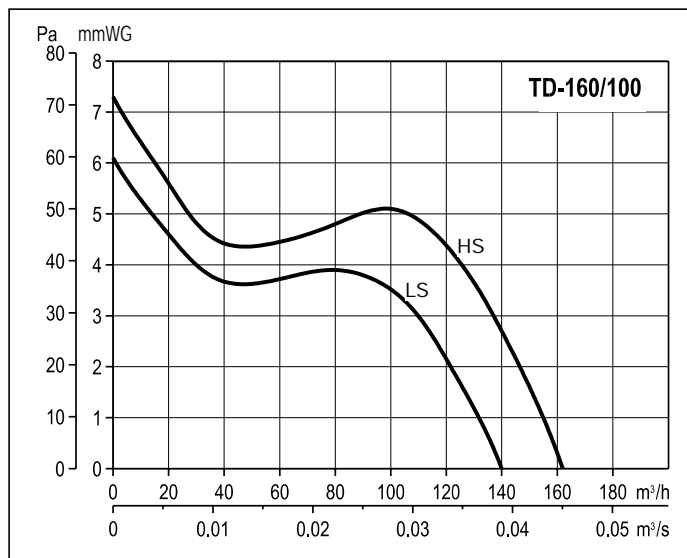

MIXVENT-TD

In-Line Duct Fans



MIXVENT TD

■ Performance curves

- Q = Air volume in, m³/hr and m³/s
- Pe = Static pressure in mmWG and Pa.
- Dry air at 20 °C and 760 mmHg.

HS = High speed
LS = Low speed

- Air flow data in accordance with the following standards: UNE 100-212-89, BS 848, Part 1, AMCA 210-85 and ASHRAE 51-1985.

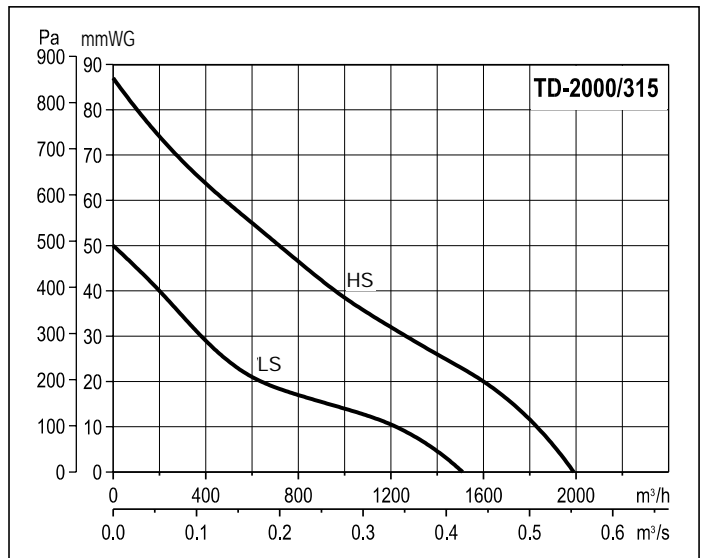
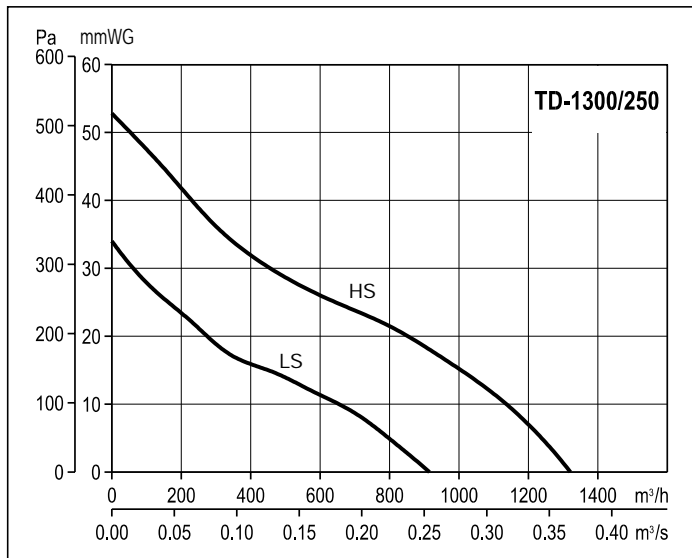
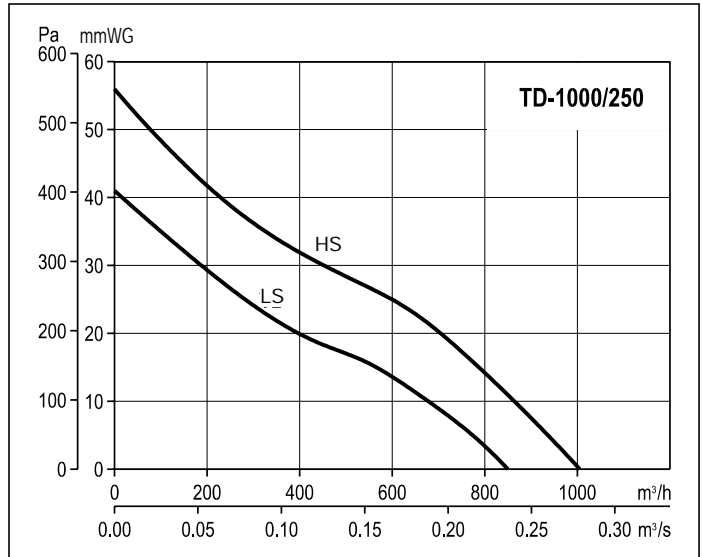
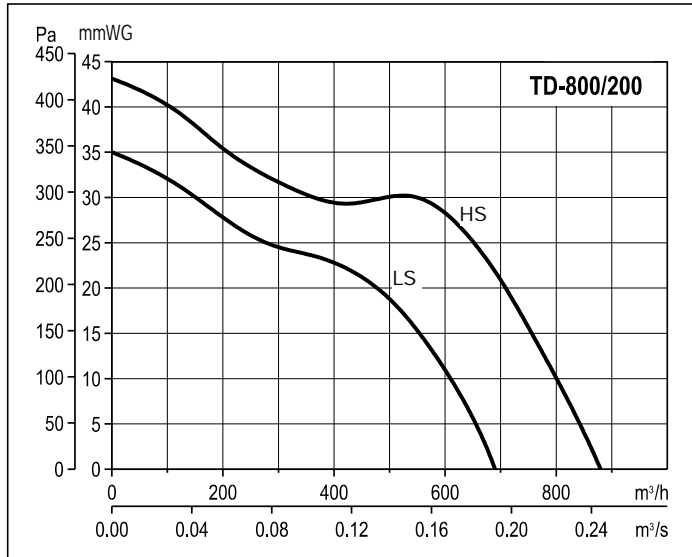



MIXVENT TDx2

■ Performance curves

- Q = Air volume in, m³/hr and m³/s
- Pe = Static pressure in mmWG and Pa.
- Dry air at 20 °C and 760 mmHg.
- Air flow data in accordance with the following standards: UNE 100-212-89, BS 848, Part 1, AMCA 210-85 and ASHRAE 51-1985.

HS = High speed
LS = Low speed

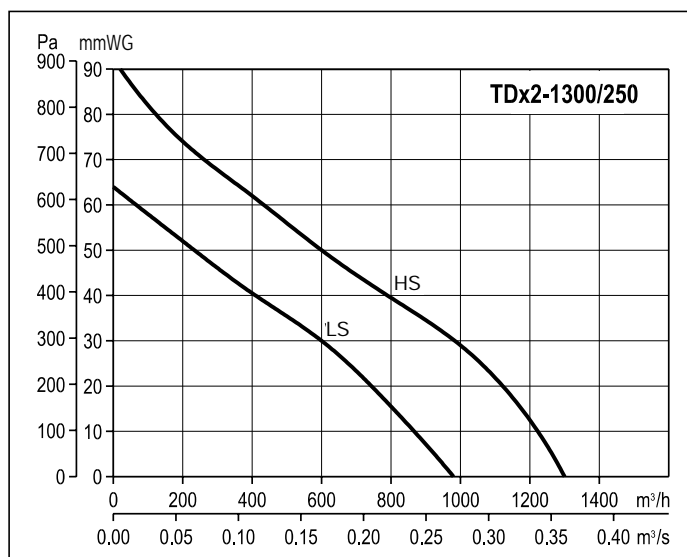
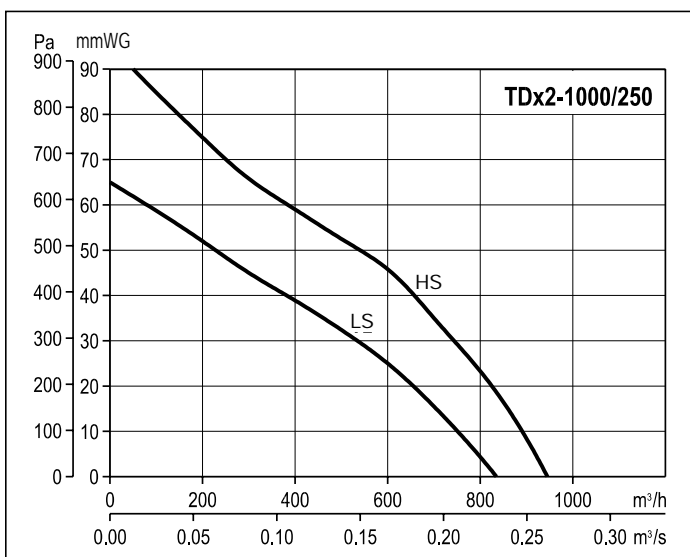
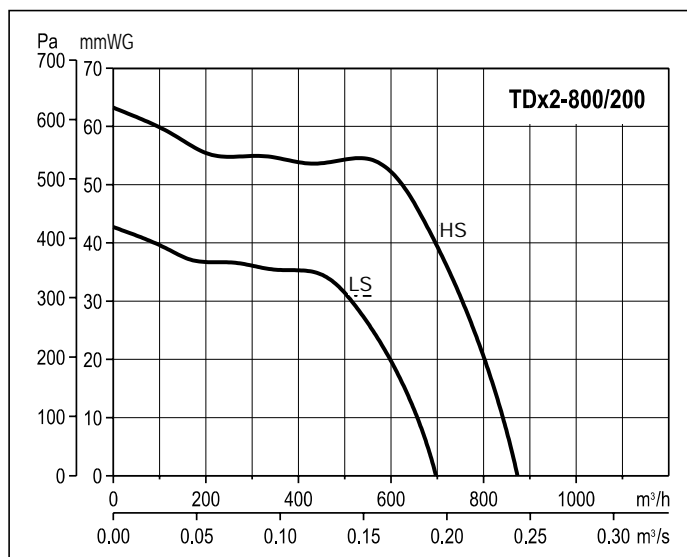
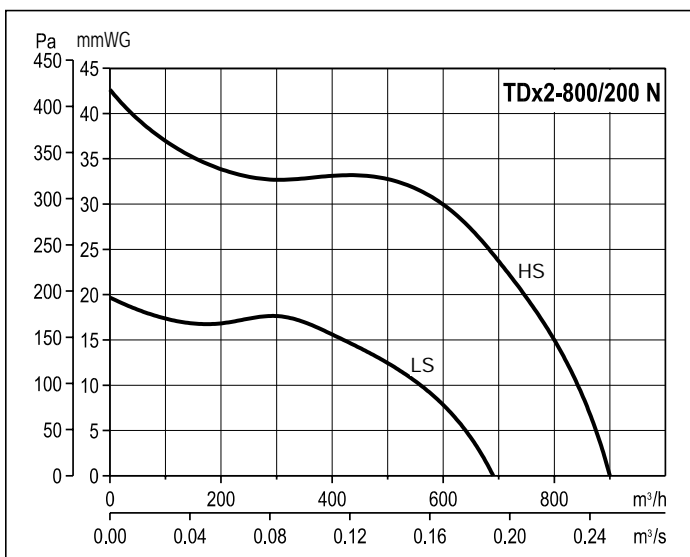
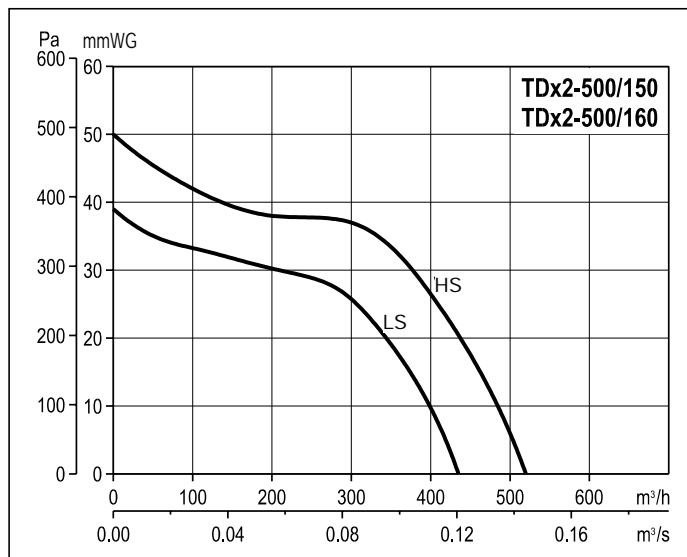
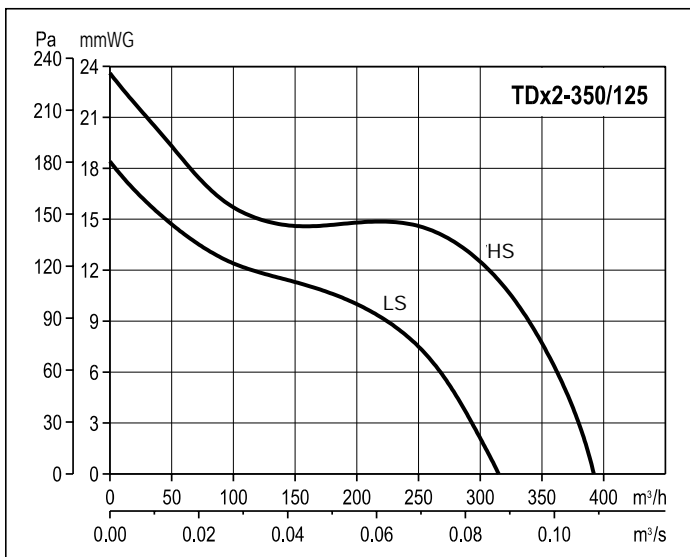

MIXVENT SYSTEM - COMBINATIONS



MIXVENT Twin

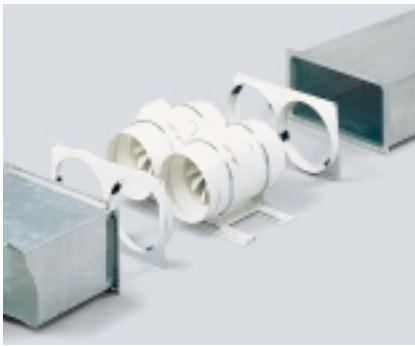

Twin

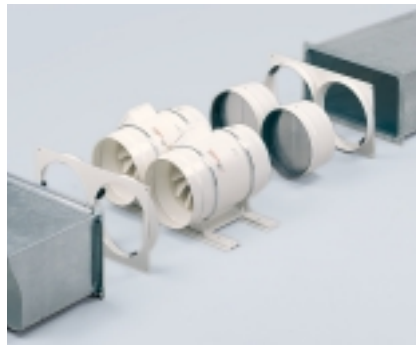

Twin with back-draft shutter accessories

Components

Kit Twin Base-250 + 2 TD -160/100
Kit Twin Base-250 + 2 TD 250/100
Kit Twin Base-350 + 2 TD -350/125
Kit Twin Base-500/150 + 2 TD-500/150
Kit Twin Base-500/160 + 2 TD-500/160
Kit Twin Base-800 + 2 TD-800/200
Kit Twin Base-1000 + 2 TD-1000/250
Kit Twin Base-1000 + 2 TD-1300/250
Kit Twin Base-2000 + 2 TD-2000/315

For back-draft shutter see accessories.

MIXVENT Twin x 2

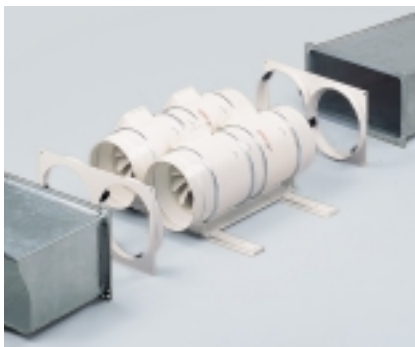

Twin x 2

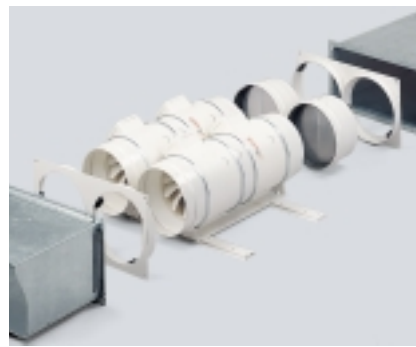

Twin x 2 with back-draft shutter accessories

Components

Kit Twin Base-350 + 2 TDx2-350/125
Kit Twin Base-500/150 + 2 TDx2-500/150
Kit Twin Base-500/160 + 2 TDx2-500/160
Kit Twin Base-800 + 2 TDx2-800/200
Kit Twin Base-1000 + 2 TDx2-1000/250
Kit Twin Base-1000 + 2 TDx2-1300/250

For back-drauff shutter see accessories.

Description

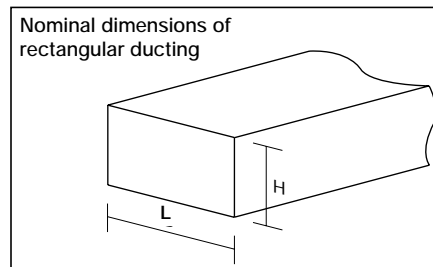
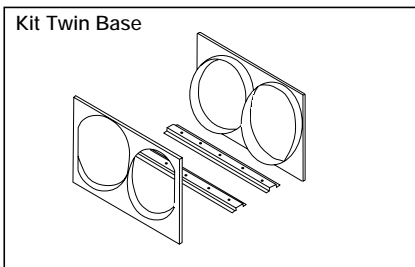

Model Type	L x H (mm)
Kit Twin base - 250	280 x 140
Kit Twin base - 350	280 x 140
Kit Twin base - 500	355 x 180
Kit Twin base - 800	400 x 200
Kit Twin base - 1000/1300	500 x 250
Kit Twin base - 2000	630 x 315

The independent operation of two TD or TDx2 fans requires the use of back-draft shutters at the discharge (outlet) in order to prevent the air recycling through a stationary fan.

MIXVENT TD x 3



TD x 3: with MBR – connection flange

Reference

Model Type	Components
TDx3-350/125	TD-350/125+TDx2-350/125+MBR-350
TDx3-500/150	TD-500/150+TDx2-500/150+MBR-500/150
TDx3-500/160	TD-500/160+TDx2-500/160+MBR-500/160
TDx3-800/200	TD-800/200+TDx2-800/200+MBR-800
TDx3-1000/250	TD-1000/250+TDx2-1000/250+MBR-1000
TDx3-1300/250	TD-1300/250+TDx2-1300/250+MBR-1000

Description

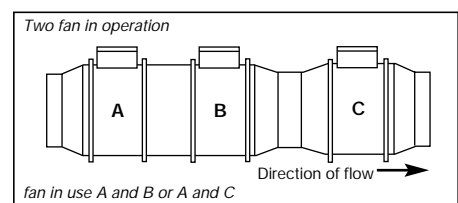
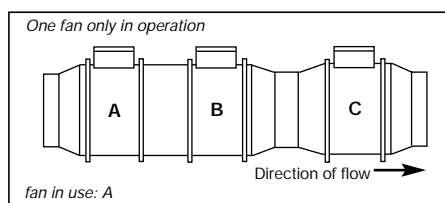
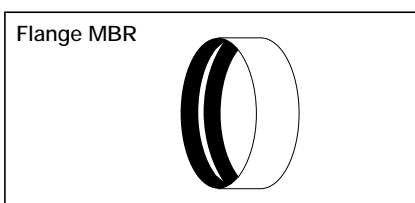

MIXVENT-TD

In-Line Duct Fans

Performance curves

- Q = Air volume in, m³/hr and m³/s
- Pe = Static pressure in mmWG and Pa.
- Dry air at 20 °C and 760 mmHg.
- Air flow data in accordance with the following standards: UNE 100-212-89, BS 848, Part 1, AMCA 210-85 and ASHRAE 51-1985.

①	Twin 350	Twin x 2-350	TD x 3-350
②	Twin 500	Twin x 2-500	TD x 3-500
③	Twin 800	Twin x 2-800	TD x 3-800
④	Twin 1000	Twin x 2-1000	TD x 3-1000
⑤	Twin 1300	Twin x 2-1300	TD x 3-1300

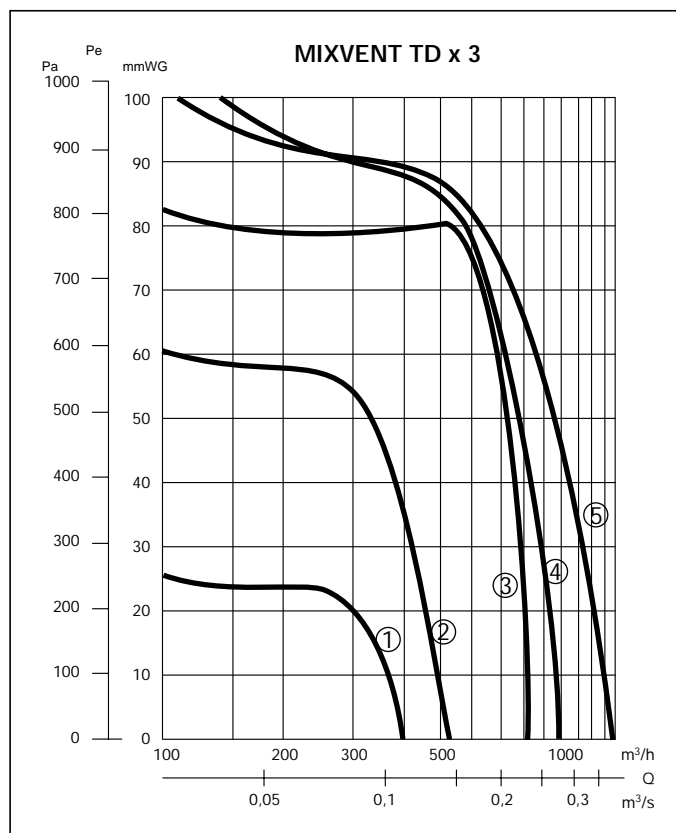
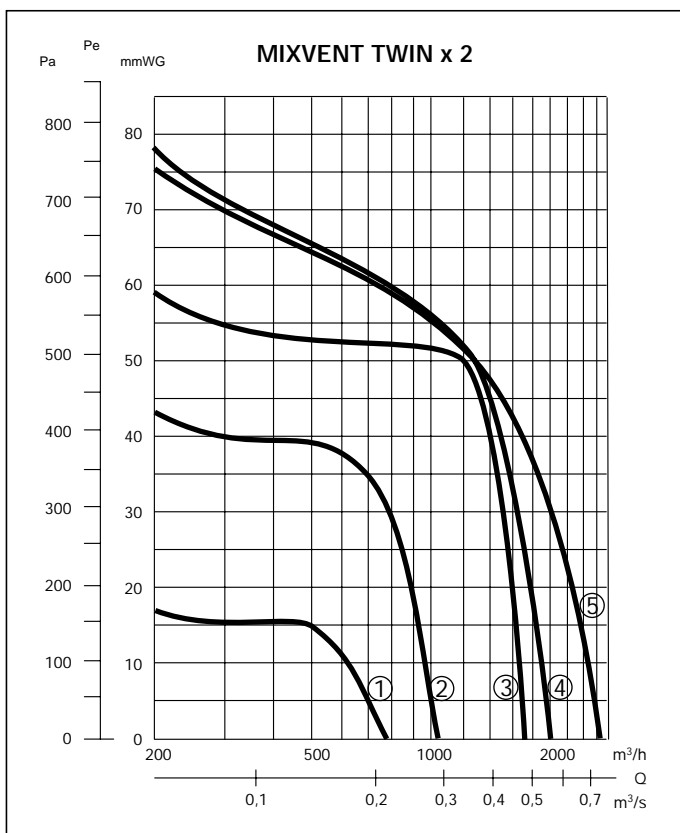
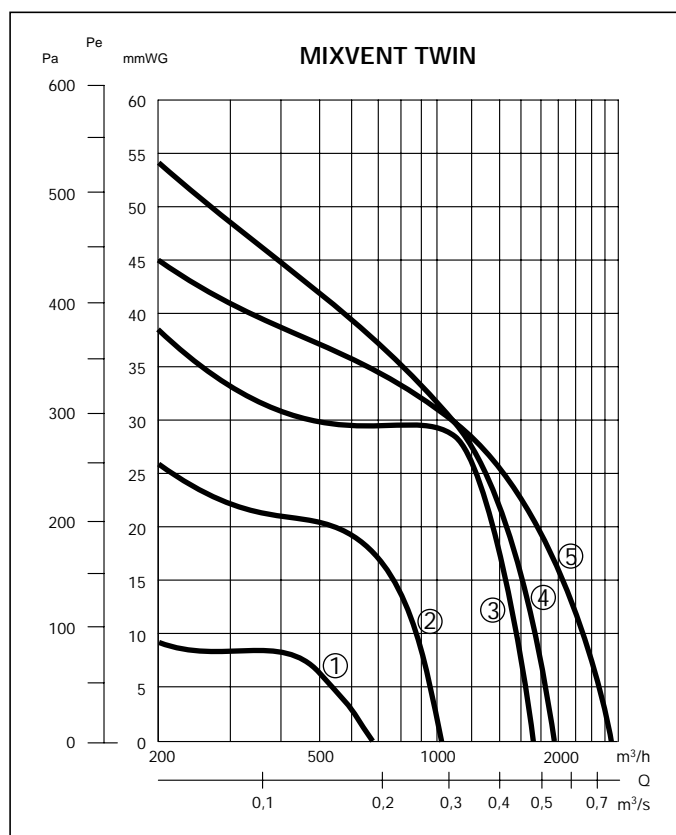

■ Acoustic characteristics

Sound Power Level Spectrum (dB(A) at octave average frequencies (Hz), measured at the fan discharge.

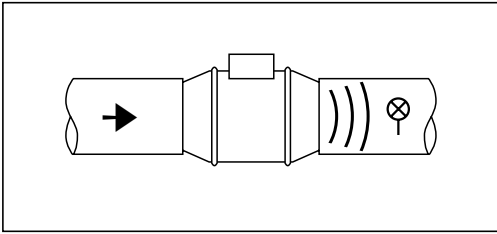

Fan Type	125	250	500	1000	2000	4000	8000
TD-160/100	37	41	55	57	49	41	32
TD-250/100	37	48	57	59	55	49	40
TD-350/125	37	49	58	60	56	50	41
TD-500/150	39	55	62	63	65	58	46
TD-500/160	39	55	62	63	65	58	46
TD-800/200-N	43	62	59	62	63	58	47
TD-800/200	44	55	70	66	68	63	54
TD-1000/250	43	57	67	73	73	67	55
TD-1300/250	43	57	67	73	73	67	55
TD-2000/315	46	60	70	75	75	69	58

Sound Power Level Spectrum (dB(A) at octave average frequencies (Hz), measured outside the fan casing (radiated noise).

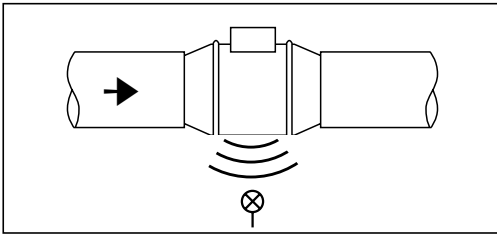

Fan Type	125	250	500	1000	2000	4000	8000
TD-160/100	30	30	35	31	28	22	20
TD-250/100	30	40	46	45	35	28	21
TD-350/125	30	41	47	46	36	29	22
TD-500/150	33	50	51	59	54	42	36
TD-500/160	33	50	51	59	54	42	36
TD-800/200-N	36	57	48	58	52	41	37
TD-800/200	37	50	59	62	57	47	44
TD-1000/250	36	52	56	69	62	51	45
TD-1300/250	36	52	56	69	62	51	45
TD-2000/315	39	55	59	72	65	54	48

Sound Power Level Spectrum (dB(A) at octave average frequencies (Hz), measured at the fan discharge.

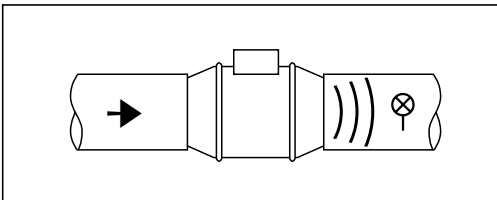

Fan Type	125	250	500	1000	2000	4000	8000
Twin x 2 - 350	42	59	68	68	65	59	49
Twin x 2 - 500	48	66	74	69	75	65	54
Twin x 2 - 800 N	53	74	70	71	74	67	56
Twin x 2 - 800	55	70	81	78	79	74	63
Twin x 2 - 1000	55	71	78	84	84	77	65
Twin x 2 - 1300	55	71	78	84	84	77	65

Sound Power Level Spectrum (dB(A) at octave average frequencies (Hz), measured outside the fan casing (radiated noise).

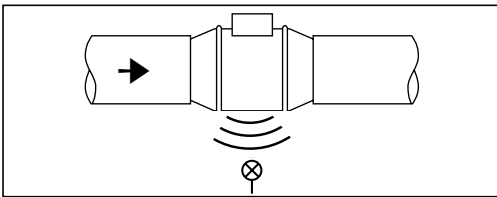

Fan Type	125	250	500	1000	2000	4000	8000
Twin x 2 - 350	35	51	57	54	45	38	30
Twin x 2 - 500	41	61	63	65	64	49	44
Twin x 2 - 800 N	46	65	59	67	64	50	46
Twin x 2 - 800	48	65	70	74	68	58	53
Twin x 2 - 1000	48	66	66	80	73	61	53

Sound Power Level Spectrum (dB(A) at octave average frequencies (Hz), measured at the fan discharge.

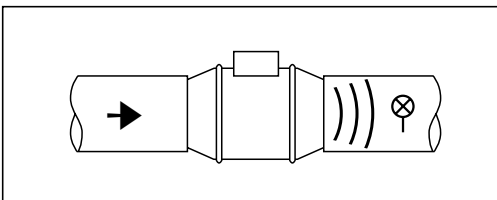

Fan Type	125	250	500	1000	2000	4000	8000
Twin x 3 - 350/125	45	57	66	63	60	56	45
Twin x 3 - 500/150	52	66	70	66	74	63	52
Twin x 3 - 500/160	52	66	70	66	74	63	52
Twin x 3 - 800/200 N	57	72	67	67	72	65	53
Twin x 3 - 800/200	59	66	71	73	76	71	60
Twin x 3 - 1000/250	58	67	69	79	81	75	61
Twin x 3 - 1300/250	58	67	69	79	81	75	61
Twin x 2 - 1300	48	66	66	80	73	61	55

Sound Power Level Spectrum (dB(A) at octave average frequencies (Hz), measured outside the fan casing (radiated noise).

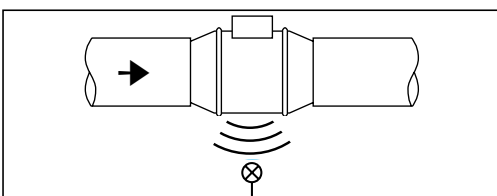

Fan Type	125	250	500	1000	2000	4000	8000
Twin x 3 - 350/125	35	51	57	54	45	38	30
Twin x 3 - 500/150	41	61	63	65	64	49	44
Twin x 3 - 500/160	41	61	63	65	64	49	44
Twin x 3 - 800/200 N	47	68	64	66	61	51	45
Twin x 3 - 800/200	48	65	70	74	68	58	53
Twin x 3 - 1000/250	48	66	66	80	73	61	55
Twin x 3 - 1300/250	48	66	66	80	73	61	55

MIXVENT-TD System Accessories



Filtration Box MFL

The MFL range of in-line heavy duty cabinet filters of type EU3 grade filtration are designed for direct connection with standard circular ducting.

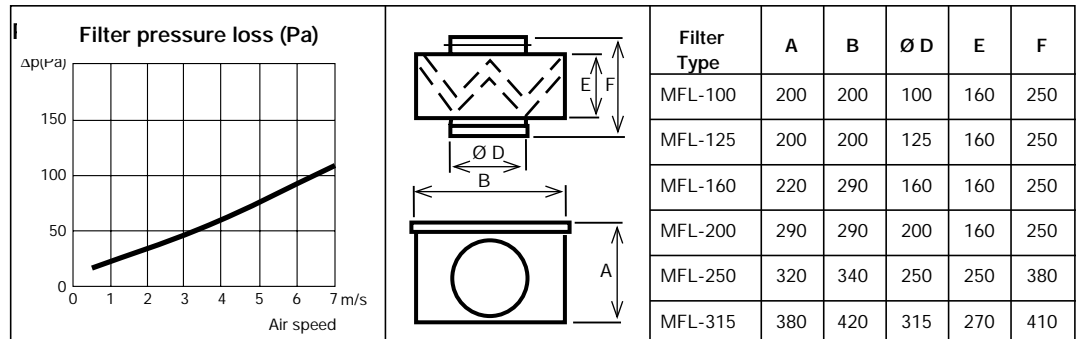

MBE, Electrical Heater Batteries

The MBE electric heater battery sections are designed to be installed on the discharge side of the MIXVENT-TD fans. The units incorporate insulated (black heat) element rods (230V – 3W/cm²) with an automatic integrated overheat thermostat (set at 90° C). This thermostat in turn is wired in series with an additional safety overheat manual reset thermostat (set at 120° C). In the case of the unit overheating the second thermostat will switch the unit off, after which the heater can then be "Reset" manually via the push button switch. All wiring terminations and connections are located on the side of the heater casing.

The heaters are available for single phase (models MBE 100, 125 and 160) or three phase (models 200, 250 and 315) electrical supply connection in conjunction with appropriate circuit protection.

- All units are supplied with an IP43 rated wiring enclosure.
- The minimum air velocity through the heater batteries must be ≥ 1.5 m/s.

A range of controllers accessories to accompany the electric heater range are available. These controllers accessories modulate the heater output as a function of the required environmental temperature (see Electrical Accessories section of this catalogue).

HEATER BATTERY SELECTION EXAMPLE
<p>DATA:</p> <ul style="list-style-type: none"> - Required air volume : 700m³/hr (Q) - Temp. of air entering: +5° C - Temp. required at discharge: +27° C <p>HEATER BATTERY POWER REQUIRED:</p> <p>$P = Q \times 0.36 \times \Delta T$ $P = 700 \times 0.36 \times (27 - 5)$ $P = 5544 \text{ W}$</p> <p>SELECTION OF HEATER:</p> <p>MBE-200/50T or MBE-250/60T</p> <p>The final selection depends upon:</p> <ul style="list-style-type: none"> - Available space - Total system pressure loss - Sound level.

Type MIXVENT-TD	Electric heater type	Heater power output (W)	Supply voltage (V)	Min. air volume (m ³ /h)	Wiring diagram*	Controller type
250/100	MBE-100/04B	400	1/230	50	E10	REG 6
350/125	MBE-125/12B	1200	1/230	70	E10	REG 6
500/160	MBE-160/21B	2100	1/230	110	E10	REG 6
800/200	MBE-200/50T	5000	2/400	170	E20	REG 6
1000-1300/250	MBE-250/60T	6000	2/400	270	E20	REG 6
2000/315	MBE-315/90T	9000	3/400	420	E30	REG 16

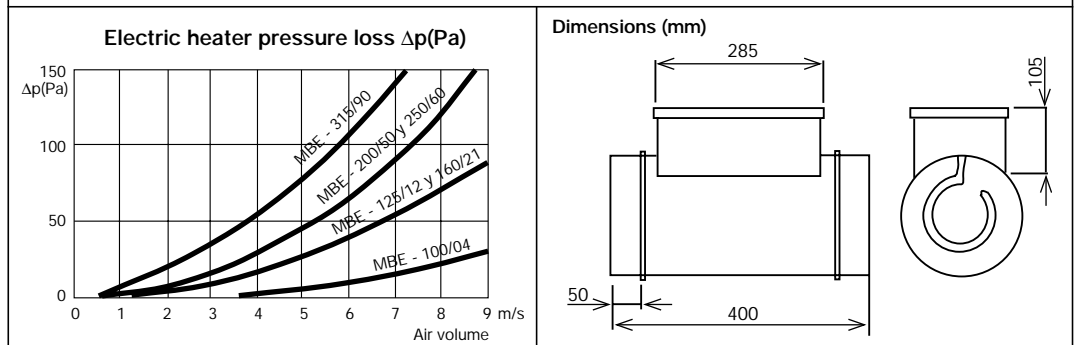
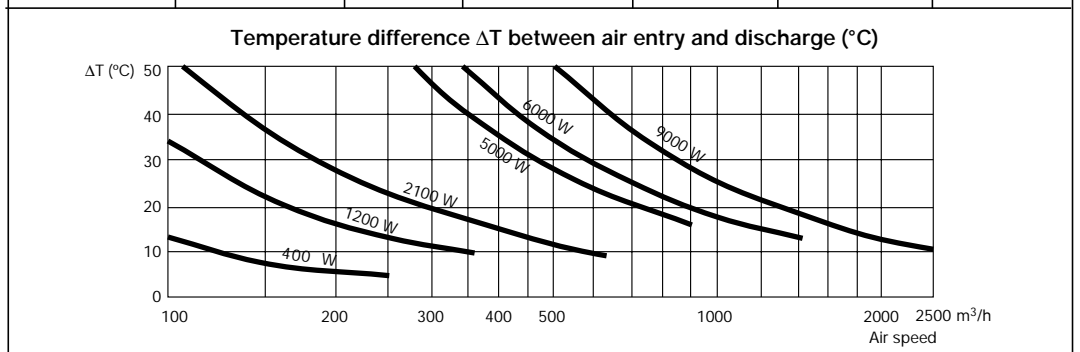

■ Installation accessories



Back-Draft Shutters – MCA

Mounted at the outlet of the MIXVENT TD and TDx2 fans, the shutter prevents the air re-circulating when the fans are not in use.

Type	TD - TD x 2 - TD x 3 - TH
MCA - 250	160/100N - 250/100
MCA - 350	350/125
MCA - 500/150	500/150
MCA - 500/160	500/160
MCA - 800	800/200 - 800/200N
MCA - 1000	1000/250 - 1300/250
MCA - 2000	2000/315

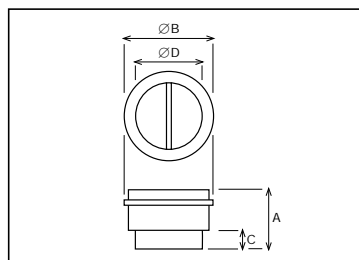

Type	A	Ø B	C	Ø D
250	107	111	31,5	94,5
350	107	136	31,5	119,5
500/150	121	163,5	35	147
500/160	121	173,5	35	157
800	131,5	214	35	197,5
1000/1300	164	264,5	42	248
2000	205	330	50	312



Rectangular Duct Adapters – MAR

The MAR adapter enables the MIXVENT TD, TDx2 or TDx3 to be connected to rectangular ducting.

Type	TD-TDx2-TDx3	Nominal dim. of ducting L x H
MAR - 250	160/100N - 250/100	224 x 140
MAR - 350	350/125	224 x 140
MAR - 500/150	500/150	280 x 180
MAR - 500/160	500/160	280 x 180
MAR - 800	800/200-800/200N	315 x 200
MAR - 1000	1000-1300/250	400 x 250
MAR - 2000	2000/315	500 X 315

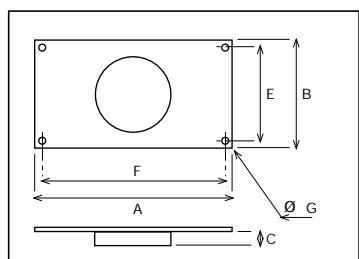

Type	A	B	C	E	F	Ø G
250/100	264	180	33,3	160	244	9
350/125	264	180	33,5	160	244	9
500/150	320	220	37	200	300	9
500/160	320	220	37	200	300	9
800/200	355	240	37	220	335	9
1000/250 - 1300/250	440	290	42	270	420	9
2000/315	540	355	52	355	520	9



Grilles – MRJ

Mounted at the inlet or outlet of the fan, the MRJ grille prevents the entry of any foreign objects.

Type	TD - TD x 2 - TD x 3
MRJ - 250	160/100N - 250/100
MRJ - 350	350/125
MRJ - 500/150	500/150
MRJ - 500/160	500/160
MRJ - 800	800/200 - 800/200N
MRJ - 1000	1000/250 - 1300/250
MRJ - 2000	2000/315



NEW

SIL
Sound attenuators

Type	Nom. diameter (mm)	Ext. diameter (mm)	Length (mm)	Attenuation in dB					
				125	250	500	1000	2000	4000
SIL 125	125	224	600	5	13	21	37	37	31
SIL 160	160	280	600	3	11	22	33	42	29
SIL 200	200	315	600	4	8	15	31	28	20
SIL 250	250	355	600	6	9	13	24	15	15
SIL 315	315	500	900	7	9	16	30	18	14

Accessories



REGUL 2
2 Speed switches



REB
Single-phase
electronic speed
controller



RMB
Single-phase
auto-transformer
speed controller.



GSA
Flexible aluminium
ducting



STC In-duct
temperature sensor
STA Ambient air
temperature sensor



PER
Outdoor plastic
louvre shutters



GSI
Flexible Acoustic
ducting



BOC
Circular air valves



**MRT
RED**
Joining pieces and
reducers

CX
Ducting Fixing clamps

Dimensions (mm)

TD-160/100N

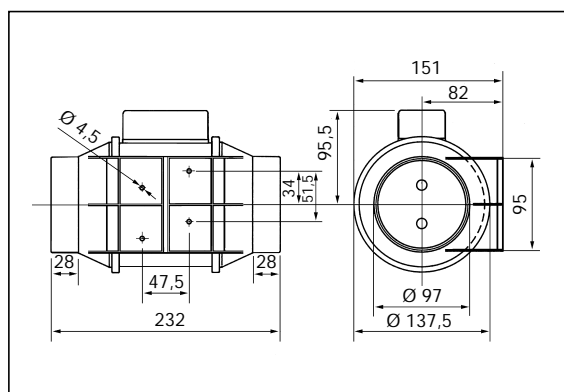

TD-250 to TD-2000

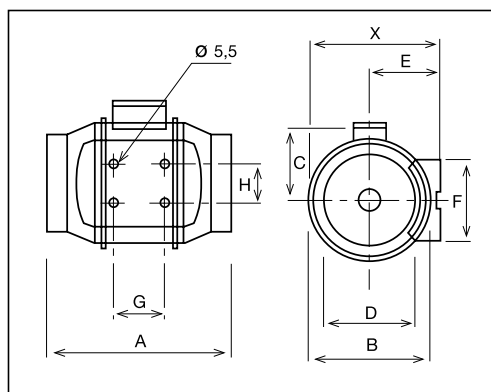

Model Type	X	A	Ø B	C	Ø D	E	F	G	H
TD-160/100N	151	232	137,5	96	98	82	95	47,5	131
TD-250/100	188	303	176	115	97	100	90	80	60
TD-350/125	188	258	176	115	123	100	90	80	60
TD-500/150	212	295	200	127	147	112	130	80	60
TD-500/160	212	275	200	127	157	112	130	80	60
TD-800/200N	232,5	302	217	141	198	124	140	100	94
TD-800/200	232,5	302	217	141	198	124	140	100	94
TD-1000/250	291	386	272	192	248	155	168	145	140
TD-1300/250	291	386	272	192	248	155	168	145	140
TD-2000/315	356	450	336	224	312	188	210	182	178

■ Dimensions (mm)

TDx2

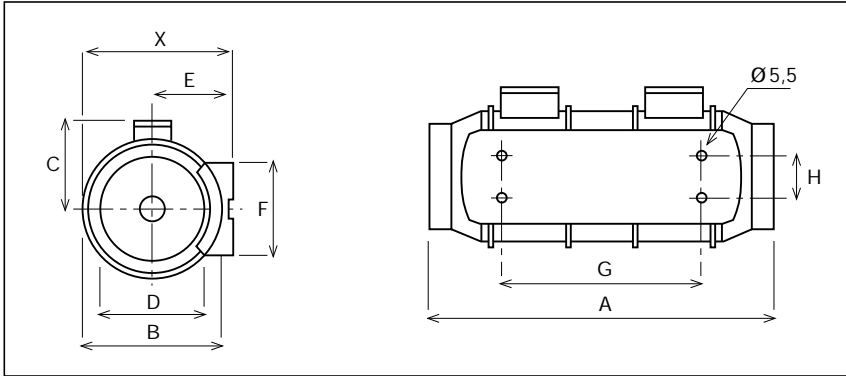

Model Type	X	A	Ø B	C	Ø D	E	F	G	H
TDx2-350/125	188,0	417	176	115	123	100	90	253	60
TDx2-500/150	212,5	464	200	127	147	111,5	130	249	60
TDx2-500/160	212,5	444	200	127	147	111,5	130	249	60
TDx2-800/200	232,5	500	217	141	198	124	140	298	94
TDx2-1000/250	291,0	654	272	192	248	155	168	416	145
TDx2-1300/250	291,0	654	272	192	248	155	168	416	145

Twin and Twin x 2

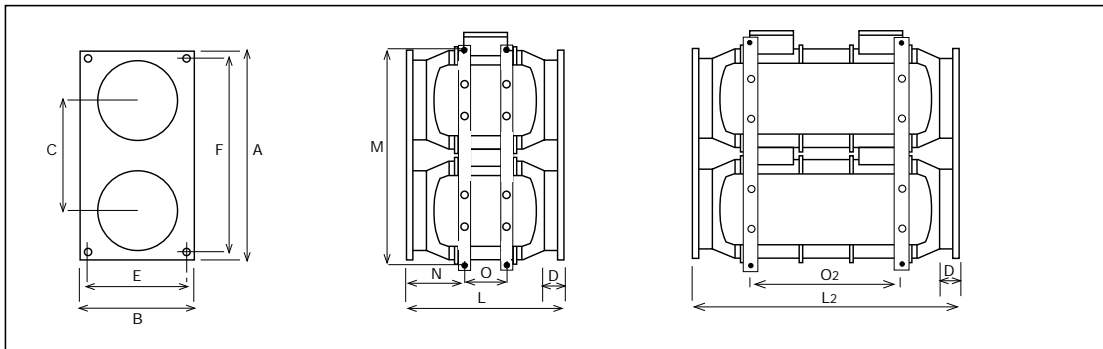

Model Type	A	B	C	D	E	F	L	L ₂	M	N	O	O ₂
Twin-250	320	180	184	36	160	300	305	-	375	113	80	-
Twin-350	320	180	184	33,5	160	300	305	475	333	91	80	253
Twin-500 (150)	395	220	206	37	200	375	310	481	417	110	80	249
Twin-500 (160)	395	220	206	37	200	375	290	461	417	100	80	249
Twin-800	440	240	225	37	220	420	317	509	456	103	100	298
Twin-1000	540	290	282	44	270	520	401	679	566	123	145	416
Twin-1300	540	290	282	44	270	520	401	679	566	123	145	416
Twin-2000	690	355	347	53	335	650	451	-	699	136	182	-

TDx3

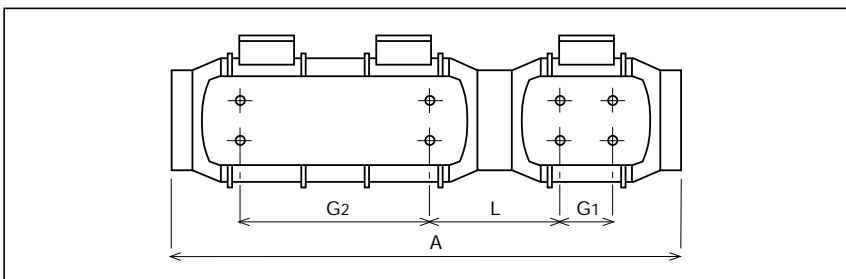

Model Type	A	G ₁	G ₂	L
TD x 3-350/125	755	80	253	213
TD x 3-500/150	766	80	249	223
TD x 3-500/160	726	80	249	203
TD x 3-800/200	801	100	298	207
TD x 3-1000/250	1055	145	416	246
TD x 3-1300/250	1055	145	416	246



MIXVENT-TD FAN KITS

TD-160/100N – TD-250/100 – TD-250/100T



Description

The TD ventilation kits enable the simple and fast installation of a complete ventilation system. The kits include the powerful TD in-line fan providing efficient extraction for bathrooms, toilets, washrooms and any other applications that require the removal of bad odours, stuffy and humid air. In addition to the fan the kits include an interior circular air valve (BOR-100); exterior mounted grille (GR-100); three meters of flexible aluminium ducting (GSA-100) and a roll of tough ducting tape to provide the complete hardware required for a given ventilation system.

Extractor fans TD-160/100N – TD-250/100 – TD-250/100T



TD-160/100N

TD-250/100
TD-250/100T

The TD range of in-line fans incorporate powerful mixed flow impellers which enable efficient and very quiet extraction against the pressures caused by ducting and grilles.

Model TD-250/100T incorporates a Run-On-Timer facility which can be adjustable between 1 to 30 minutes. (factory set to 15 mins)

The TD range has been specifically designed with an integrated mounting support which enables the fast installation and access to the motor / impeller assembly without having to remove or disturb the adjoining ducting.

Technical characteristics

Model Type	Nom. speed (r.p.m.)	Power abs. at free discharge (W)	Maximum current (A)	Duty at free discharge (m ³ /h)	Maximum operating temperature (°C)	Sound pressure level (dB(A))	Weight (kg)
TD-160/100N	2500	35	0,25	160	40	18	1,4
TD-250/100 – TD-250/100T	1800	89	0,26	250	40	24	2,0

Installation

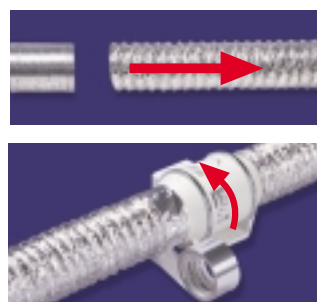
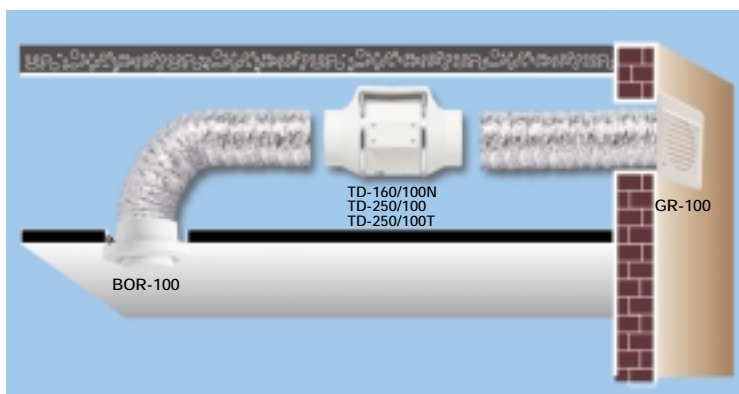

Accessories included in Kit



GSA-100
Flexible aluminium tubing with adhesive duct tape



GR-100
Exterior mounted grille



BOR-100
Interior circular air valve.