



Low profile acoustic cabinet fans, manufactured from galvanised sheet steel and internally lined with 50mm thickness of fireproof acoustic fiberglass insulation (M0), with sound-absorbent insulation at the inlet. All models incorporate inlet and discharge circular duct connection flanges with integrated rubber air seal. Direct drive backward curved centrifugal fan. Brushless EC motor, IP44, with thermal overload protection, suitable for single phase supply 230V +/- 15%-50/60Hz. Fan supply with external ON-OFF electrical isolation switch, and potentiometer to adjust the fan speed. Also possible to control the fan speed with external potentiometer type REB-ECOWATT or analogue input signal 0-10V. This cabinet fan has been designed for indoor use, with inlet air temperatures between -20°C up to +40°C and suitable for mounting in any orientation.



ON-OFF electrical isolation switch and potentiometer to adjust the fan speed from 10 to 100%.



Low noise level
 Acoustic insulation of 50 mm thickness fireproof fiberglass (M0) with a high resistance coating reducing the noise level significantly.



Sound-absorbent insulation at the inlet.

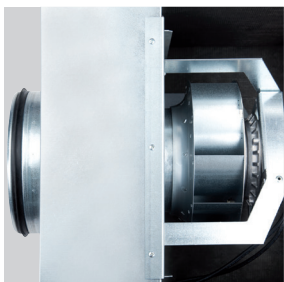

Direct drive backward centrifugal impeller
 The impeller is factory matched to the EC external rotor motor.

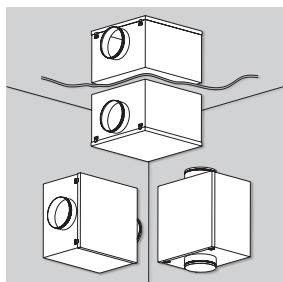

Installation in any orientation
 Possibility to be installed upright, horizontal or inverted.

TECHNICAL CHARACTERISTICS

Before installation check that the product electrical characteristics listed on the data plate label (voltage, power, frequency, etc.) match those of the intended electrical supply.

Model	Input signal voltage (V)	Speed (r.p.m.)	Maximum absorbed power (W)	Maximum absorbed current (A)	Maximum airflow (m ³ /h)	Sound pressure level * (dB(A) to 1,5 m)			Weight (kg)
						Outlet	Inlet	Radiated	
CAB-125 ECOWATT	10	3900	75	0,5	400	46	51	37	13
	8	3550	57	0,4	355	44	49	35	
	6	2600	27	0,2	260	37	42	34	
	4	1800	12	0,1	185	28	33	25	
CAB-150 ECOWATT	10	3270	103	0,7	600	47	50	38	15
	8	2980	78	0,6	540	45	47	36	
	6	2300	38	0,3	410	39	41	33	
	4	1610	16	0,1	280	30	33	26	
CAB-160 ECOWATT	10	3270	102	0,7	590	47	51	41	15
	8	3020	81	0,5	530	45	49	40	
	6	2350	41	0,3	410	39	43	36	
	4	1620	18	0,1	280	30	34	27	
CAB-200 ECOWATT	10	2570	161	1,1	1.090	48	53	39	23
	8	2195	100	0,7	910	44	49	36	
	6	1715	50	0,4	710	37	43	31	
	4	1250	23	0,2	520	29	36	26	
CAB-250 ECOWATT	10	2650	219	1,4	1.220	52	58	42	24
	8	2390	162	1,1	1.100	47	50	29	
	6	1905	85	0,6	880	42	45	27	
	4	1410	40	0,3	660	37	38	21	
CAB-315 ECOWATT	10	1990	238	1,0	1.910	54	57	52	28
	8	1670	143	0,6	1.610	50	53	48	
	6	1390	88	0,4	1.360	45	48	40	
	4	1060	46	0,2	1.010	38	42	35	
CAB-355 ECOWATT	10	1940	335	1,4	2.580	54	58	49	32
	8	1685	224	1,0	2.260	52	55	46	
	6	1380	130	0,6	1.840	50	50	39	
	4	1070	69	0,3	1.440	40	43	33	
CAB-400 ECOWATT	10	1940	335	1,4	2.650	54	55	48	32
	8	1695	229	1,1	2.320	50	53	48	
	6	1380	131	0,6	1.900	45	48	40	
	4	1070	68	0,3	1.460	38	42	35	

* Punto medio de la curva.

DIMENSIONS (mm)

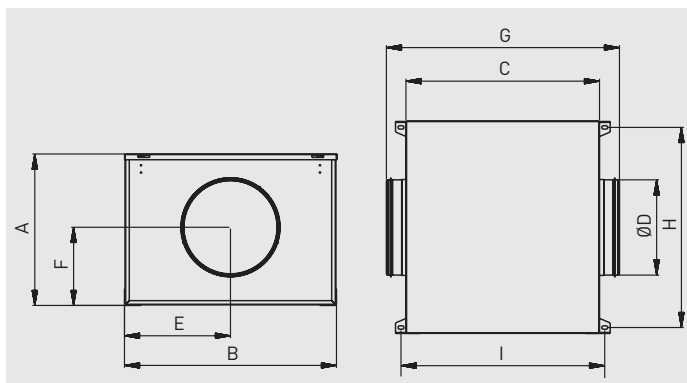

Model	A	B	C	D	E	F	G	H	I
CAB-125 ECOWATT	316	420	386	125	210	163	433	389	412
CAB-150 ECOWATT	334	447	415	150	224	174	517	416	441
CAB-160 ECOWATT	334	447	415	160	224	174	517	416	441
CAB-200 ECOWATT	375	510	468	200	255	193	570	479	494
CAB-250 ECOWATT	395	553	505	250	277	204	608	522	535
CAB-315 ECOWATT	441	609	555	315	305	221	659	585	580
CAB-355 ECOWATT	501	699	578	355	350	251	682	668	606
CAB-400 ECOWATT	501	699	578	400	350	251	682	668	606

PERFORMANCE CURVES

- q_v : Airflow in m^3/h .
- p_{st} : Static pressure in Pa.
- SFP: Specific fan power in $W/m^3/s$ (blue curves).
- Dry air at 20°C and 760 mmHg.
- Performance data in accordance with ISO 5801 and AMCA 210-99 Standards.

CAB-125 ECOWATT

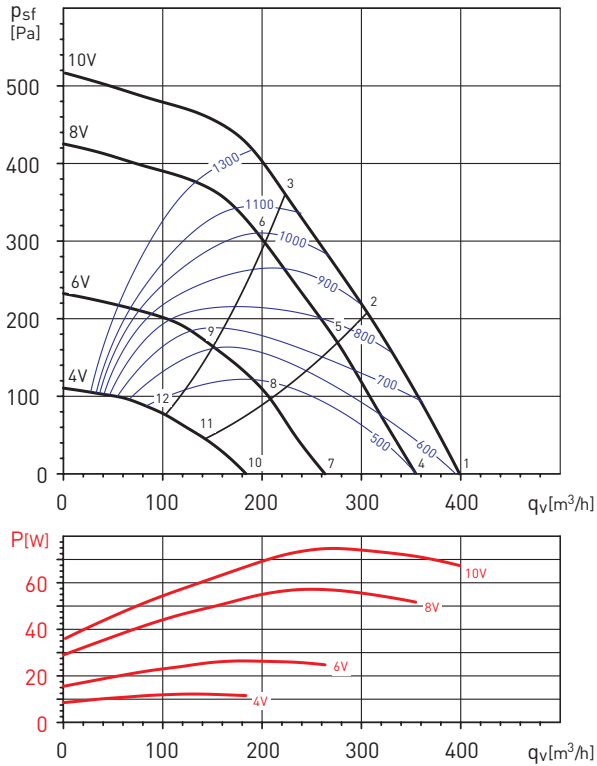

Sound power level spectrums in dB(A)

Working point		63	125	250	500	1.000	2.000	4.000	8.000	LwA
1	Inlet	39	47	52	60	61	60	55	57	66
	Outlet	40	49	50	51	56	57	55	48	62
	Radiated	40	47	46	43	41	44	42	40	53
2	Inlet	37	44	52	60	61	57	54	55	65
	Outlet	38	47	47	49	54	56	53	46	60
	Radiated	37	44	46	43	40	42	41	38	51
3	Inlet	34	42	53	59	61	56	52	53	65
	Outlet	35	44	47	48	53	55	52	45	59
	Radiated	35	42	47	42	41	41	40	36	51
4	Inlet	39	44	50	57	59	57	53	54	64
	Outlet	47	46	47	49	53	54	52	45	59
	Radiated	37	44	45	41	38	42	40	38	50
5	Inlet	38	42	50	57	59	55	51	52	63
	Outlet	47	45	45	47	51	53	50	42	58
	Radiated	35	42	45	42	38	39	38	35	49
6	Inlet	37	41	51	56	59	54	50	49	62
	Outlet	47	43	45	46	50	53	49	42	57
	Radiated	34	40	46	40	38	38	37	33	49
7	Inlet	36	40	49	52	52	51	48	44	58
	Outlet	35	41	46	42	46	47	44	34	53
	Radiated	38	39	45	37	37	39	36	32	48
8	Inlet	36	38	50	51	51	49	46	41	57
	Outlet	35	41	45	41	44	46	42	31	52
	Radiated	38	37	46	37	35	37	34	29	48
9	Inlet	36	38	48	52	50	48	43	39	56
	Outlet	34	41	44	40	44	48	41	32	52
	Radiated	38	37	44	38	35	36	32	27	47
10	Inlet	24	31	36	42	43	43	37	26	48
	Outlet	25	33	34	33	36	39	34	23	43
	Radiated	23	32	33	30	30	32	33	25	40
11	Inlet	24	31	37	42	42	40	33	26	47
	Outlet	24	32	34	32	33	37	31	23	42
	Radiated	23	32	33	30	28	29	29	25	39
12	Inlet	23	30	35	42	41	38	30	25	46
	Outlet	24	33	34	33	35	37	29	23	42
	Radiated	22	32	32	30	28	27	25	24	38

PERFORMANCE CURVES

- q_v : Airflow in m^3/h .
- p_{sf} : Static pressure in Pa.
- SFP: Specific fan power in $W/m^3/s$ (blue curves).
- Dry air at 20°C and 760 mmHg.
- Performance data in accordance with ISO 5801 and AMCA 210-99 Standards.

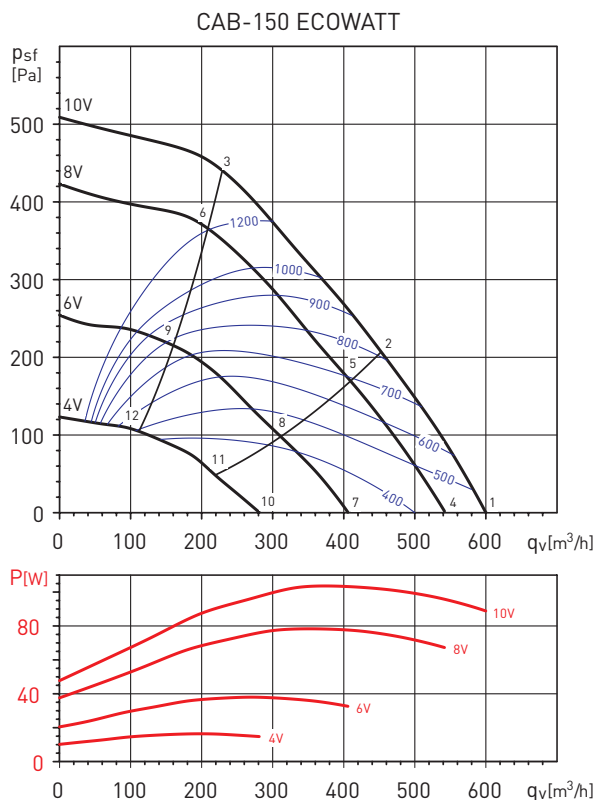

Sound power level spectrums in dB(A)

Working point		63	125	250	500	1.000	2.000	4.000	8.000	LwA
1	Inlet	43	49	53	59	61	59	58	51	66
	Outlet	44	52	52	53	57	57	54	44	62
	Radiated	42	45	48	46	43	45	42	34	54
2	Inlet	40	49	52	58	58	56	55	49	64
	Outlet	39	51	50	50	55	56	52	43	61
	Radiated	39	45	47	45	40	41	39	32	52
3	Inlet	38	47	56	59	59	55	54	49	64
	Outlet	38	49	53	50	55	58	53	45	62
	Radiated	37	43	51	46	41	41	37	32	53
4	Inlet	41	47	52	57	59	57	56	48	64
	Outlet	41	50	50	50	54	55	52	41	60
	Radiated	42	44	48	43	42	43	40	33	52
5	Inlet	39	47	51	55	56	53	53	46	61
	Outlet	36	50	49	48	53	54	50	40	59
	Radiated	40	43	46	41	39	40	37	31	50
6	Inlet	36	45	54	56	56	53	51	46	62
	Outlet	34	48	52	47	54	55	50	43	60
	Radiated	37	42	50	42	39	39	35	31	52
7	Inlet	35	42	47	51	53	52	48	38	58
	Outlet	33	44	45	43	47	48	45	31	54
	Radiated	35	39	44	38	37	40	35	28	48
8	Inlet	32	41	47	49	50	48	44	36	55
	Outlet	32	44	45	43	46	48	43	31	53
	Radiated	32	38	45	35	34	36	31	26	47
9	Inlet	30	42	47	49	49	47	43	37	55
	Outlet	31	46	47	42	49	49	42	33	55
	Radiated	31	38	44	36	34	35	30	27	46
10	Inlet	27	35	40	43	45	43	34	26	50
	Outlet	29	37	37	34	38	39	31	23	45
	Radiated	25	34	38	30	31	35	28	24	42
11	Inlet	26	34	39	41	42	40	32	26	47
	Outlet	29	35	36	33	37	39	29	23	44
	Radiated	25	33	36	28	28	31	25	24	40
12	Inlet	26	39	39	41	42	37	31	25	47
	Outlet	28	40	35	40	41	39	30	23	46
	Radiated	24	37	36	28	28	29	25	23	41

PERFORMANCE CURVES

- q_v : Airflow in m^3/h .
- p_{st} : Static pressure in Pa.
- SFP: Specific fan power in $W/m^3/s$ (blue curves).
- Dry air at $20^\circ C$ and 760 mmHg.
- Performance data in accordance with ISO 5801 and AMCA 210-99 Standards.

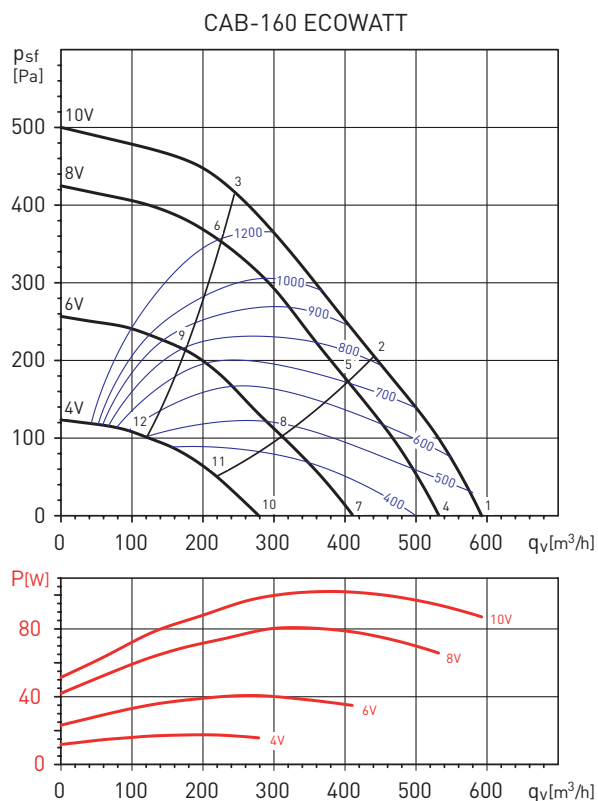

Sound power level spectrums in dB(A)

Working point		63	125	250	500	1.000	2.000	4.000	8.000	LwA
1	Inlet	41	48	54	62	63	61	57	50	67
	Outlet	44	51	51	52	55	58	55	45	62
	Radiated	44	46	48	46	50	52	51	42	57
2	Inlet	38	46	54	60	60	57	54	48	65
	Outlet	38	49	48	50	54	56	53	43	60
	Radiated	41	44	47	44	46	48	48	40	55
3	Inlet	34	45	54	60	59	56	52	48	65
	Outlet	36	47	50	49	53	55	52	45	60
	Radiated	37	43	48	44	46	47	46	40	54
4	Inlet	39	46	53	59	61	59	55	47	65
	Outlet	41	49	50	49	53	56	53	42	60
	Radiated	40	45	47	44	49	51	49	40	56
5	Inlet	36	44	53	57	57	55	52	45	63
	Outlet	36	48	48	47	52	54	51	41	59
	Radiated	38	43	46	42	45	47	46	38	53
6	Inlet	34	44	53	58	57	54	50	45	63
	Outlet	34	46	49	47	51	53	50	43	58
	Radiated	35	43	46	43	45	46	44	38	53
7	Inlet	32	41	49	53	55	53	48	38	60
	Outlet	32	43	45	42	47	50	46	32	54
	Radiated	35	41	43	40	43	46	43	33	51
8	Inlet	29	38	47	51	51	49	43	36	56
	Outlet	29	42	44	41	46	49	44	32	53
	Radiated	32	38	41	38	39	41	38	31	47
9	Inlet	27	37	48	52	51	49	43	37	57
	Outlet	28	44	45	41	45	47	42	34	52
	Radiated	30	37	42	39	40	41	38	32	48
10	Inlet	25	36	39	45	47	46	33	25	51
	Outlet	25	36	38	34	38	40	31	23	45
	Radiated	17	29	31	38	39	38	26	18	44
11	Inlet	25	35	38	43	44	42	31	25	48
	Outlet	32	35	34	33	38	39	30	23	44
	Radiated	18	27	30	35	36	34	23	17	41
12	Inlet	21	35	37	43	43	39	31	25	48
	Outlet	22	37	34	33	38	38	31	24	44
	Radiated	14	27	30	35	35	32	23	17	40

PERFORMANCE CURVES

- q_v : Airflow in m^3/h .
- p_{sf} : Static pressure in Pa.
- SFP: Specific fan power in $W/m^3/s$ (blue curves).
- Dry air at 20°C and 760 mmHg.
- Performance data in accordance with ISO 5801 and AMCA 210-99 Standards.

CAB-200 ECOWATT

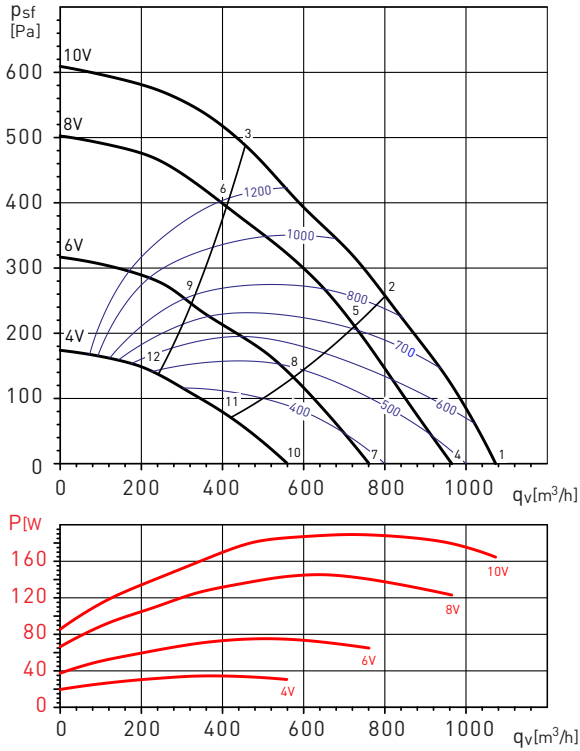

Sound power level spectrums in dB(A)

Working point		63	125	250	500	1.000	2.000	4.000	8.000	LwA
1	Inlet	50	53	63	65	68	61	63	60	72
	Outlet	49	57	57	56	60	61	56	50	66
	Radiated	52	44	49	46	50	47	44	50	58
2	Inlet	44	49	61	61	63	58	62	58	69
	Outlet	43	53	54	53	58	59	55	50	64
	Radiated	46	40	47	42	45	43	43	48	54
3	Inlet	38	48	66	65	65	59	62	58	71
	Outlet	38	50	57	52	56	60	55	50	64
	Radiated	40	40	53	46	47	45	42	48	56
4	Inlet	47	50	61	62	65	59	61	57	69
	Outlet	46	54	55	53	58	59	54	46	64
	Radiated	50	42	47	44	48	45	42	51	56
5	Inlet	42	46	60	59	61	56	59	55	67
	Outlet	41	50	52	51	55	57	53	47	62
	Radiated	45	38	46	40	44	42	40	49	53
6	Inlet	35	48	64	62	63	57	59	55	69
	Outlet	36	48	55	50	54	58	52	49	62
	Radiated	38	39	50	44	46	43	40	49	55
7	Inlet	42	44	56	57	59	53	55	46	64
	Outlet	39	48	51	48	52	53	48	36	58
	Radiated	43	36	44	39	43	39	36	41	50
8	Inlet	36	42	53	54	56	51	53	47	61
	Outlet	35	44	48	46	50	52	49	38	57
	Radiated	38	34	42	36	40	36	35	41	47
9	Inlet	31	49	56	56	57	51	52	47	62
	Outlet	32	46	49	46	49	52	50	42	57
	Radiated	32	41	45	38	40	37	34	41	49
10	Inlet	33	39	46	50	51	47	45	35	56
	Outlet	31	40	40	43	46	46	38	27	51
	Radiated	35	34	38	34	36	34	30	24	43
11	Inlet	29	38	45	49	49	45	44	36	54
	Outlet	29	38	38	41	45	46	37	26	50
	Radiated	30	32	36	32	33	32	29	25	41
12	Inlet	26	43	48	49	49	43	44	35	55
	Outlet	30	45	42	41	43	46	42	30	51
	Radiated	28	38	39	33	34	31	28	25	43

PERFORMANCE CURVES

- q_v : Airflow in m^3/h .
- p_{st} : Static pressure in Pa.
- SFP: Specific fan power in $W/m^3/s$ (blue curves).
- Dry air at 20°C and 760 mmHg.
- Performance data in accordance with ISO 5801 and AMCA 210-99 Standards.

CAB-250 ECOWATT

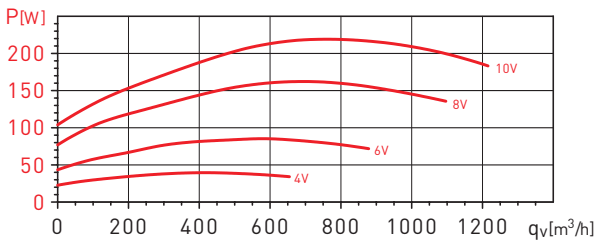
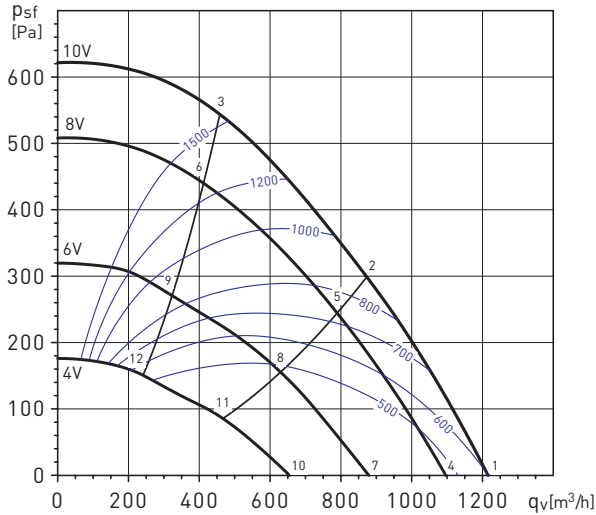

Sound power level spectrums in dB(A)

Working point		63	125	250	500	1.000	2.000	4.000	8.000	LwA
1	Inlet	42	54	66	68	71	67	63	58	75
	Outlet	48	54	60	57	61	64	60	51	68
	Radiated	40	44	55	50	50	45	37	32	58
2	Inlet	40	52	65	65	66	64	63	58	72
	Outlet	41	51	60	53	58	62	58	51	66
	Radiated	38	41	55	47	46	42	36	31	56
3	Inlet	38	54	68	67	68	66	64	60	74
	Outlet	40	51	60	55	59	65	60	54	68
	Radiated	36	44	58	49	47	45	38	33	59
4	Inlet	39	52	64	65	68	64	60	56	72
	Outlet	45	52	58	54	58	62	57	48	66
	Radiated	37	44	53	48	49	44	36	31	56
5	Inlet	38	50	62	63	64	62	60	55	69
	Outlet	40	49	57	50	55	60	55	48	64
	Radiated	35	42	52	46	44	42	36	30	54
6	Inlet	36	54	65	64	65	64	62	57	71
	Outlet	38	50	58	52	56	63	57	51	66
	Radiated	33	45	54	47	45	44	37	32	56
7	Inlet	36	49	59	59	63	59	53	49	67
	Outlet	39	48	56	48	52	56	50	41	61
	Radiated	33	42	49	43	44	39	31	27	52
8	Inlet	33	47	58	57	58	56	53	48	64
	Outlet	34	45	54	46	51	55	48	41	59
	Radiated	30	40	48	41	39	37	31	26	50
9	Inlet	32	52	58	58	59	58	54	49	65
	Outlet	33	48	52	46	51	57	50	43	60
	Radiated	29	45	49	42	40	39	32	27	51
10	Inlet	29	45	49	52	55	52	45	38	59
	Outlet	32	44	41	40	44	49	41	32	52
	Radiated	28	40	38	35	36	33	29	25	44
11	Inlet	28	47	48	50	51	49	43	38	56
	Outlet	30	44	41	41	45	48	39	32	52
	Radiated	27	41	37	33	32	31	28	25	44
12	Inlet	27	47	49	51	52	50	45	38	57
	Outlet	31	46	42	43	47	49	40	33	53
	Radiated	26	42	38	34	32	32	29	26	45

PERFORMANCE CURVES

- q_v : Airflow in m^3/h .
- p_{sf} : Static pressure in Pa.
- SFP: Specific fan power in $W/m^3/s$ (blue curves).
- Dry air at $20^\circ C$ and 760 mmHg .
- Performance data in accordance with ISO 5801 and AMCA 210-99 Standards.

CAB-315 ECOWATT

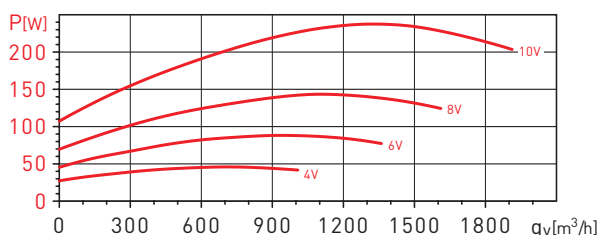
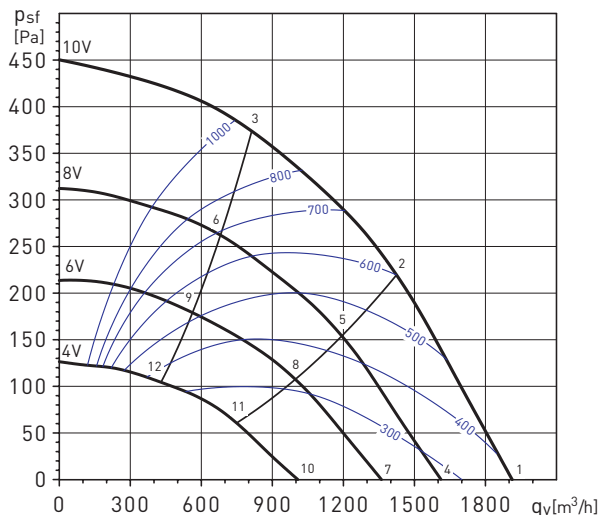

Sound power level spectrums in dB(A)

Working point		63	125	250	500	1.000	2.000	4.000	8.000	LwA
1	Inlet	41	54	67	67	66	63	59	57	72
	Outlet	47	57	66	59	64	60	53	46	69
	Radiated	42	48	65	54	57	54	49	46	66
2	Inlet	41	54	67	66	64	59	56	53	71
	Outlet	43	55	65	56	62	58	51	44	68
	Radiated	42	48	65	53	55	50	46	42	66
3	Inlet	41	58	67	66	64	58	55	51	71
	Outlet	41	53	63	56	62	60	56	48	68
	Radiated	42	52	65	53	54	49	45	40	66
4	Inlet	39	53	62	63	63	58	53	54	68
	Outlet	43	55	62	55	59	56	48	42	65
	Radiated	40	46	59	49	53	53	43	41	61
5	Inlet	40	54	64	61	59	53	49	49	67
	Outlet	41	53	61	52	58	53	45	38	64
	Radiated	40	47	61	47	50	48	39	36	62
6	Inlet	38	58	62	61	59	54	49	45	67
	Outlet	39	51	58	52	58	56	51	40	63
	Radiated	38	51	59	47	50	49	39	31	60
7	Inlet	39	54	57	59	59	53	49	50	64
	Outlet	41	56	52	50	57	51	43	40	61
	Radiated	39	50	50	45	51	44	38	36	56
8	Inlet	37	55	54	57	55	48	45	40	62
	Outlet	38	54	49	47	55	48	40	36	59
	Radiated	37	51	47	43	48	39	34	26	54
9	Inlet	35	57	54	57	55	49	44	39	62
	Outlet	35	52	48	47	56	50	42	35	59
	Radiated	35	52	47	43	48	40	33	25	55
10	Inlet	35	48	50	55	52	43	46	31	58
	Outlet	37	49	46	46	49	43	40	30	54
	Radiated	37	45	44	43	48	37	36	24	52
11	Inlet	32	46	48	54	48	41	37	29	56
	Outlet	34	46	42	47	47	41	34	30	52
	Radiated	33	42	41	42	45	34	27	22	49
12	Inlet	33	48	49	55	49	41	36	30	58
	Outlet	33	45	42	46	47	42	31	29	52
	Radiated	34	44	42	43	46	35	26	23	50

PERFORMANCE CURVES

- q_v : Airflow in m^3/h .
- p_{sf} : Static pressure in Pa.
- SFP: Specific fan power in $W/m^3/s$ (blue curves).
- Dry air at 20°C and 760 mmHg.
- Performance data in accordance with ISO 5801 and AMCA 210-99 Standards.

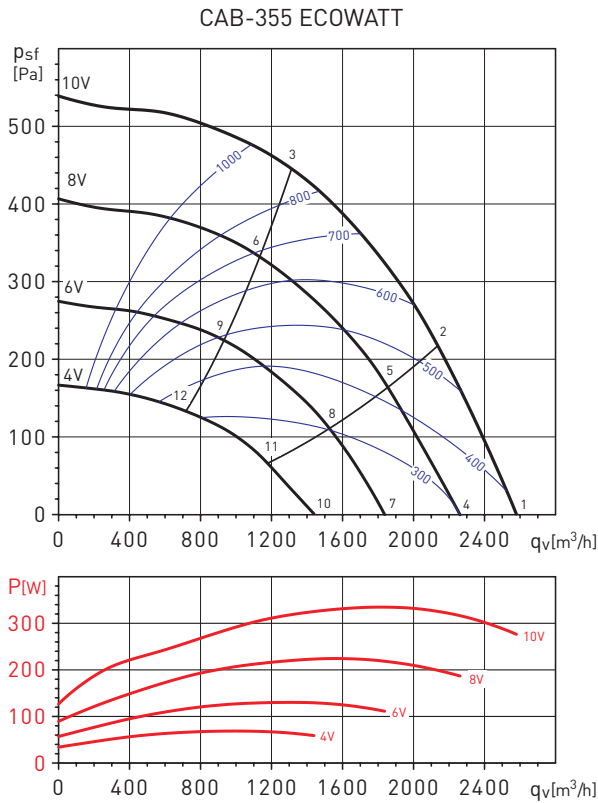

Sound power level spectrums in dB(A)

Working point		63	125	250	500	1.000	2.000	4.000	8.000	LwA
1	Inlet	46	58	67	67	67	66	64	63	74
	Outlet	52	59	63	62	66	62	55	49	70
	Radiated	41	49	62	53	55	53	48	49	64
2	Inlet	42	55	67	66	66	63	60	59	72
	Outlet	45	55	63	59	63	60	52	46	68
	Radiated	37	46	61	52	54	51	45	45	63
3	Inlet	39	58	65	64	63	60	58	55	70
	Outlet	41	55	61	56	61	58	51	46	66
	Radiated	34	48	60	50	51	47	42	41	61
4	Inlet	41	58	64	64	65	63	58	61	71
	Outlet	48	56	62	58	63	59	51	46	67
	Radiated	36	49	59	49	53	51	42	48	61
5	Inlet	37	55	64	62	63	58	55	56	69
	Outlet	41	53	63	54	61	56	48	42	66
	Radiated	32	46	59	47	51	46	38	42	60
6	Inlet	37	61	61	60	58	52	52	48	67
	Outlet	38	53	61	51	59	54	47	41	64
	Radiated	32	52	56	45	46	40	36	35	58
7	Inlet	37	58	57	60	65	58	54	57	68
	Outlet	42	58	52	52	63	53	46	42	65
	Radiated	34	50	47	44	50	45	38	44	56
8	Inlet	33	58	55	58	60	51	50	50	64
	Outlet	37	56	49	49	63	51	42	37	64
	Radiated	30	51	45	42	45	38	34	37	53
9	Inlet	34	56	53	56	57	48	47	42	62
	Outlet	35	54	47	46	63	49	41	34	63
	Radiated	29	50	44	40	49	35	31	29	53
10	Inlet	32	51	52	55	56	49	52	38	61
	Outlet	36	52	46	47	52	47	43	30	57
	Radiated	30	43	42	46	45	37	39	30	51
11	Inlet	29	49	50	52	50	43	46	33	57
	Outlet	33	49	43	45	51	44	38	26	54
	Radiated	27	41	40	43	39	31	33	25	47
12	Inlet	28	47	47	50	47	40	39	33	54
	Outlet	31	45	41	42	50	41	33	26	52
	Radiated	26	39	37	41	36	28	26	25	45

PERFORMANCE CURVES

- q_v : Airflow in m^3/h .
- p_{st} : Static pressure in Pa.
- SFP: Specific fan power in $W/m^3/s$ (blue curves).
- Dry air at 20°C and 760 mmHg.
- Performance data in accordance with ISO 5801 and AMCA 210-99 Standards.

CAB-400 ECOWATT

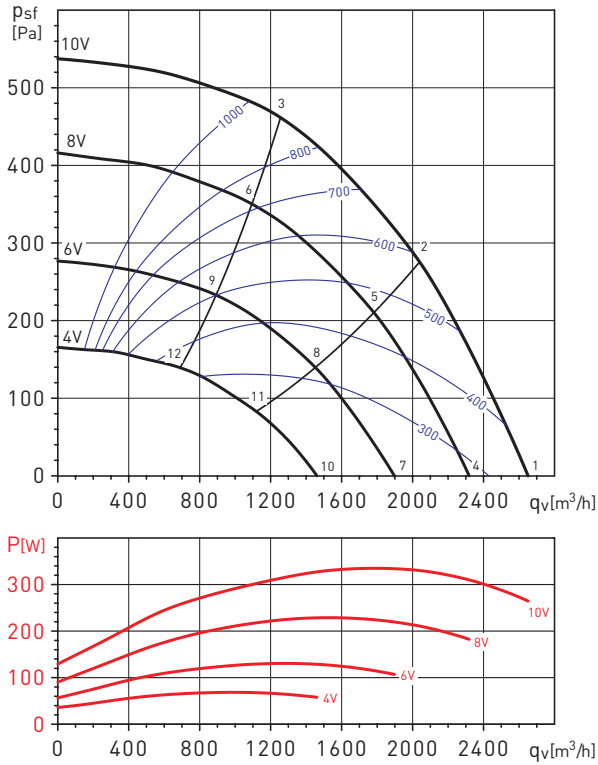

Sound power level spectrums in dB(A)

Working point		63	125	250	500	1.000	2.000	4.000	8.000	LwA
1	Inlet	46	58	65	67	65	66	61	57	72
	Outlet	46	59	64	63	67	63	56	49	71
	Radiated	44	50	62	56	58	58	51	47	65
2	Inlet	40	54	63	64	62	60	53	51	69
	Outlet	41	54	63	59	64	60	52	46	68
	Radiated	38	46	60	53	55	52	44	41	62
3	Inlet	41	58	64	63	58	54	51	47	68
	Outlet	41	57	61	58	62	58	53	47	67
	Radiated	39	50	61	52	51	46	41	38	62
4	Inlet	39	53	62	63	63	58	53	54	68
	Outlet	43	55	62	55	59	56	48	42	65
	Radiated	40	46	59	49	53	53	43	41	61
5	Inlet	40	54	64	61	59	53	49	49	67
	Outlet	41	53	61	52	58	53	45	38	64
	Radiated	40	47	61	47	50	48	39	36	62
6	Inlet	38	58	62	61	59	54	49	45	67
	Outlet	39	51	58	52	58	56	51	40	63
	Radiated	38	51	59	47	50	49	39	31	60
7	Inlet	39	54	57	59	59	53	49	50	64
	Outlet	41	56	52	50	57	51	43	40	61
	Radiated	39	50	50	45	51	44	38	36	56
8	Inlet	37	55	54	57	55	48	45	40	62
	Outlet	38	54	49	47	55	48	40	36	59
	Radiated	37	51	47	43	48	39	34	26	54
9	Inlet	35	57	54	57	55	49	44	39	62
	Outlet	35	52	48	47	56	50	42	35	59
	Radiated	35	52	47	43	48	40	33	25	55
10	Inlet	35	48	50	55	52	43	46	31	58
	Outlet	37	49	46	46	49	43	40	30	54
	Radiated	37	45	44	43	48	37	36	24	52
11	Inlet	32	46	48	54	48	41	37	29	56
	Outlet	34	46	42	47	47	41	34	30	52
	Radiated	33	42	41	42	45	34	27	22	49
12	Inlet	33	48	49	55	49	41	36	30	58
	Outlet	33	45	42	46	47	42	31	29	52
	Radiated	34	44	42	43	46	35	26	23	50

MOUNTING ACCESSORIES



MBE
 Electric heaters.



MFL-G4
 Filtration boxes.



ACOPEL F400 N
 Circular flexible connector.



KSE-45
 Flexible supports
 Rubber anti-vibration mounts to reduce vibration and noise transmission to the installation.
 [1KSE = set of 4 supports per bag].

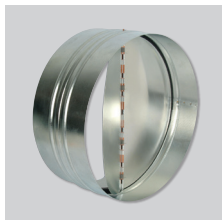

CAR
 Circular back draft shutters.



APC
 Discharge protection guards for direct connection to the inlet-outlet flange. (please see pages Mounting Accessories).

ELECTRICAL ACCESSORIES



CONTROL ECOWATT AC/DC
 Control element for demand controlled ventilation systems.



CONTROL ECOWATT BASIC
 Speed control and single-phase ON/OFF.



REB-ECOWATT
 Speed controller for fans fitted with EC motor.



SC02-A
 CO₂ and temperature sensor.
SC02-AD
 CO₂ and temperature sensor, with display.
SCHT-AD
 CO₂ sensor, temperature and relative humidity with display.



TDP-S / TDP-D
 Presure sensor.



CPFL-S / CPFL-E
 Presence detector.



REMP
 Motorised dampers.