

# Technical Manual of Holtop

## Energy Recovery Ventilator

Models:  
XHBQ-D1.5DCTPA to XHBQ-D20DCTPA



### Attention

Please read this manual carefully before using the equipment  
KAFFE S.A. VENTILATION CENTER





# Contents



















Safety Considerations-----	3,4
Unit Specifications-----	5,6
Dimensioned Drawings-----	7,8
Installation Considerations-----	9,10,11
Electrical Installation-----	12
Wiring Diagrams-----	13,14
Commissioning Information-----	15
Intelligent Controller-----	16 to 19
Dia Switch -----	20
Modbus Table -----	21
Maintenance -----	22

# Safety Considerations

Please read the following safety instructions before installation. And ensure that the unit is installed correctly.







Please observe all instruction in order to avoid any injury or damage to equipment or property.

<b>Safety attentions</b>			
The following symbols indicate potential levels of caution.			
 <b>Warning</b>	Situations with a risk or death or serious injure.	 <b>Attention</b>	Situations with a risk of injury or equipment/property damage.
The following symbols indicate compliance which must be observed			
	Not allowed or Stop		Must follow  or obliged

 <b>Warning</b>			
	Installation to be carried out by qualified person, End Users must not install, move or re-install this equipment by themselves		An anti-bird net or similar device should be installed to outside vents. Ensure there are no obstructions to or in the ducts
	Installation engineers must follow this manual strictly. Improper action can create a health hazard and reduce efficiency of the unit		Fresh air vent must be far enough away from any flue gas discharge or areas where hazardous vapors are present
	Unit must be installed strictly following this manual and mounted to a weight bearing surface for the weight of the unit		Electric engineering must follow national regulations and the manual, use special cables. Less capacity cables and improper engineering can cause electric shock or fire.
	During maintenance or repair, the unit and circuit breaker must be switched off. Otherwise electric shock could occur.		Ground wire cannot be connected to gas pipe, water pipe, lighting rod or telephone line etc. Incorrect grounding can cause electric shock.
 <b>Attention</b>			
	Power cable and wires must be installed by a qualified electrical engineer. Improper connection can cause over heating. Fire and loss of efficiency.		To avoid condensation, insulation should be fitted to fresh air ducts. Other ducting may also require insulation depending on dew point conditions.
	Insulation between the metal ducting and wall penetration must be installed if the ducting penetrates metal wall cladding, to avoid risk of electric shock or current leakage.		The cover of wiring box must be pressed down and closed to avoid dust and dirt entering. Excess dust and dirt can cause overheating of terminals and result in fire or electric shock.
	Use only approved installation hardware and accessories. Failure to observe can result in fire risk, electric shock and equipment failure		Where the unit is positioned, at high level in a hot humid situation. Please ensure sufficient ventilation is available
	The outdoor ducts must be installed facing downwards to avoid rain water entering. Improper installation can cause water leakage.		Correctly sized MCB must be fitted to the unit suitable earth leakage protection should also be installed to avoid risk of electric shock or fire.

# Safety Considerations

## Safety Considerations

 <b>Attention</b>	
 Do not install the unit in an extremely humid conditions, as it may result in electric shock and pose a fire risk.	 Do not use the units as the primary kitchen extract grease and fatty deposits can block the heat exchanger, filter and pose a fire risk.
 Don not install the unit in areas there any poisonous or caustic gases are present.	 Do not install the unit near open flame as it may result in over heating and pose a fire risk
 Acidic or alkali environments can cause poisoning or a fire	 Rated supply voltage must be maintained, otherwise this may cause fire.

# Specifications

Model		XHBQ-D1.5DCTPA	XHBQ-D2.5DCTPA	XHBQ-D3.5DCTPA	XHBQ-D5DCTPA
Performance					
Airflow (m <sup>3</sup> /h)		150	250	350	500
Airflow (l/s)		43	71	100	143
Enth. Eff (%)	Heating	70-76	70-75	69-75	67-75
	Cooling	63-70	63-73	66-72	62-74
Temp. Eff (%)		75-82	75-82	75-84	75-86
Noise Db(A)		31.5	34.5	37.5	39
Power Supply		220-240V/1Ph/50Hz			
Input Power (W)		26	46	60	88
Power Cable		2x1.5mm <sup>2</sup>			
Control Cable		2x0.5mm <sup>2</sup>			
Control	Standard	Yes (7-Day Time-clock)			
	(BMS) Modbus	Yes			
Fan Type		DC Fan Motors			
Fan Speeds (Supply)		10 Speed Fan Control			
Fan Speeds (Exhaust)		10 Speed Fan Control			
Summer Bypass		Yes (Automatic with adjustable range)			
Defrost		Yes (Automatic with adjustable range)			
CO <sub>2</sub> Control		Optional controller available (On / Off control with adjustable range)			
Humidity Control		Optional controller available (On / Off control with adjustable range)			
Fan Boost Contacts		Yes (1x available connection to Contact: Closed = Boost to High Speed)			
Fire Shutdown		Yes (1x available connection to Contact: Closed = Shutdown)			
Weight (Kg)		25	29	37	43
Size (WxHxD)		580x264x808	599x264x882	804x270x882	904x270x962
Duct Size		150	150	150	200

# Specifications

Model		XHBQ-D6.5DCTPA	XHBQ-D8DCTPA	XHBQ-D10DCTPA	XHBQ-D15DCTPA	XHBQ-D20DCTPA
Performance						
Airflow(m <sup>3</sup> /h)		650	800	1000	1500	2000
Airflow (l/s)		186	229	286	429	571
Enth. Eff (%)	Heating	68-73	71-77	71-78	71-77	71-78
	Cooling	62-70	65-74	65-74	65-74	65-74
Temp. Eff (%)		75-84	75-84	75-85	75-84	75-85
Noise Db(A)		39.5	42	43	50	51.5
Power Supply		220-240V/1Ph/50Hz				
Input Power (W)		114	186	243	372	486
Power Cable		2x1.5mm <sup>2</sup>				
Control Cable		2x0.5mm <sup>2</sup>				
Control	Standard	Yes (7-Day Time-clock)				
	(BMS) Modbus	Yes			No	
Fan Type		DC Fan Motors				
Fan Speeds (Supply)		10 Speed Fan Control				
Fan Speeds (Exhaust)		10 Speed Fan Control				
Summer Bypass		Yes (Automatic with adjustable range)				
Defrost		Yes (Automatic with adjustable range)				
CO <sub>2</sub> Control		Optional controller available (On / Off control with adjustable range)				
Humidity Control		Optional controller available (On / Off control with adjustable range)				
Fan Boost Contacts		Yes (1x available connection to Contact: Closed = Boost to High Speed)				
Fire Shutdown		Yes (1x available connection to Contact: Closed = Shutdown)				
Weight (Kg)		64	71	83	165	189
Size (WxHxD)		884x340x1222	884x388x1322	1134x388x1322	884x785x1322	1134x785x1322
Duct Size		200	250	250	300	300

# Dimensioned Drawings

## XHBQ-D1.5DCTPA to D5DCTPA Models

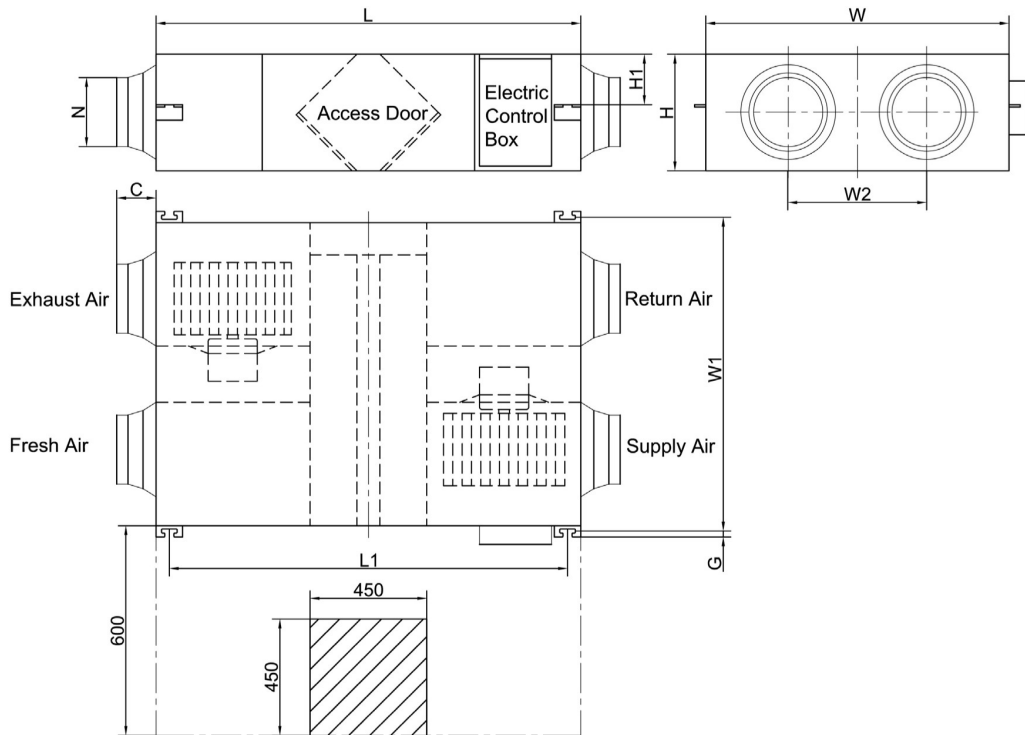

## XHBQ-D6.5DCTPA to D10DCTPA Models

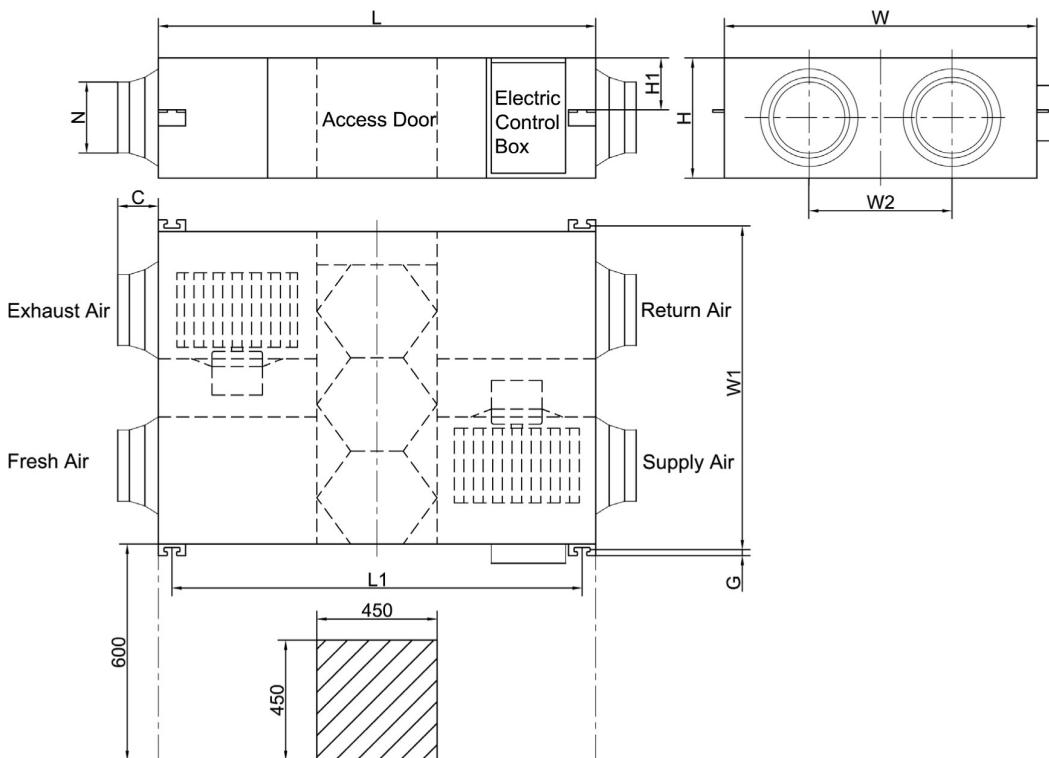

# Dimensioned Drawings

## XHBQ-D15DCTPA to D20DCTPA Models

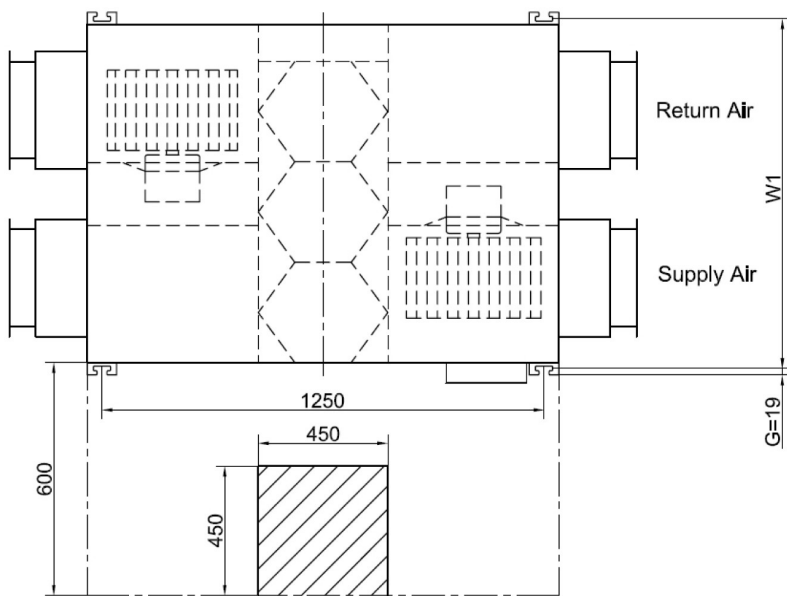
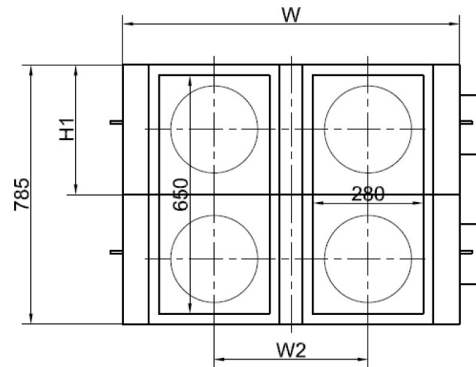
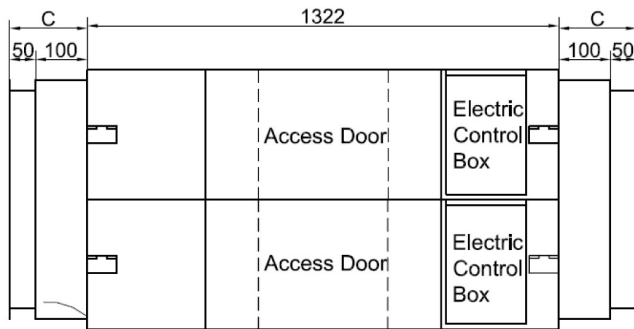

Model	Dia. (mm)
XHBQ-D1.5DCTPA	Φ150
XHBQ-D2.5DCTPA	Φ150
XHBQ-D3.5DCTPA	Φ150
XHBQ-D5DCTPA	Φ200
XHBQ-D6.5DCTPA	Φ200
XHBQ-D8DCTPA	Φ250
XHBQ-D10DCTPA	Φ250
XHBQ-D15DCTPA	280*650
XHBQ-D20DCTPA	280*650

## Diagram Measurements

The table on right side shows suitable duct measurements for each unit.

The table below shows the dimensions of the image above and the two images previously, the letter in the table represents the letter on the diagram .

Model	L	L1	W	W1	W2	H	H1	C	G	N
XHBQ-D1.5DCTPA	808	867	580	510	290	264	20	100	19	Φ144
XHBQ-D2.5DCTPA	882	810	599	657	315	270	111	100	19	Φ144
XHBQ-D3.5DCTPA	882	810	804	860	480	270	111	100	19	Φ144
XHBQ-D5DCTPA	962	890	904	960	500	270	111	107	19	Φ194
XHBQ-D6.5DCTPA	1222	1150	884	940	480	340	146	107	19	Φ194
XHBQ-D8DCTPA	1322	1250	884	940	428	388	170	85	19	Φ242
XHBQ-D10DCTPA	1322	1250	1134	1190	678	388	170	85	19	Φ242
XHBQ-D15DCTPA	1322	1250	884	940	428	785	170	150	19	280*650
XHBQ-D20DCTPA	1322	1250	1134	1190	678	785	170	150	19	280*650



# Installation Considerations

## Installation Considerations

Protect the unit to avoid dust or other obstructions entering the unit and accessories during installation, or whilst in storage on site. Service ports should be installed to allow access for filter maintenance.

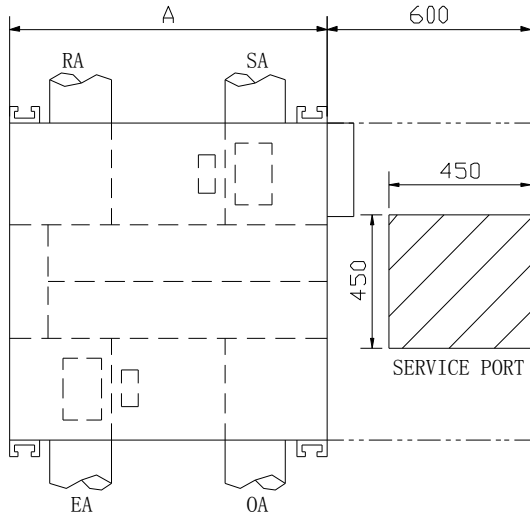

XHBQ-D1.5DCTPA

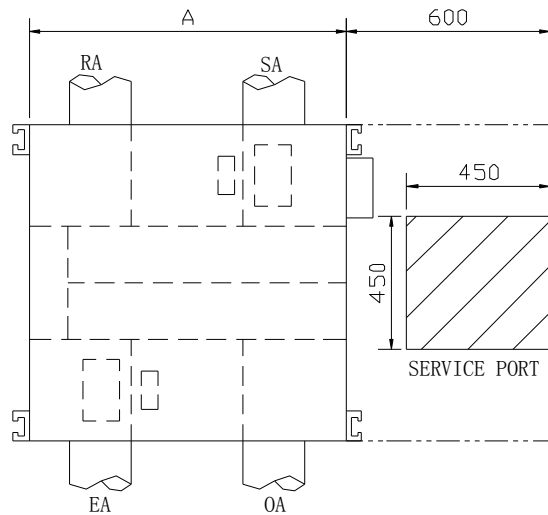

XHBQ-D2.5DCTPA to D5DCTPA

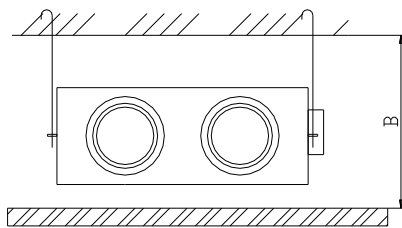

Dimensions Model	Ceiling Height	
	A	B
XHBQ-D1.5DCTPA	580	320
XHBQ-D2.5DCTPA	599	320
XHBQ-D3.5DCTPA	804	320
XHBQ-D5DCTPA	904	320
XHBQ-D6.5DCTPA	884	390
XHBQ-D8DCTPA	884	440
XHBQ-D10DCTPA	1134	440
XHBQ-D15DCTPA	884	835
XHBQ-D20DCTPA	1134	835

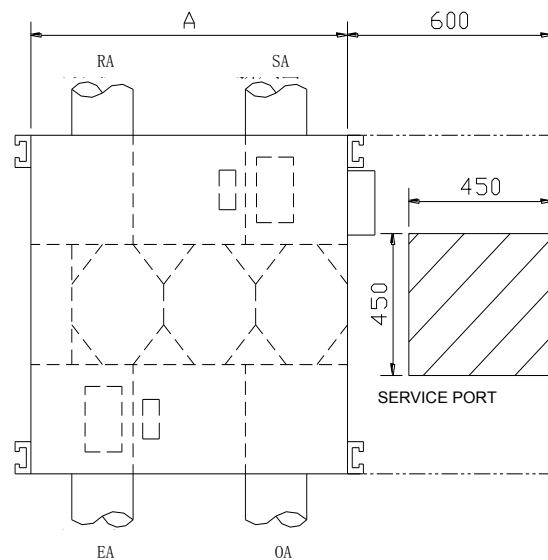

XHBQ-D6.5DCTPA to D20DCTPA

1. Be sure the ceiling height is no less than the Figures in above table B column.
2. Unit must not be installed close to boiler flues.
3. Following phenomenon should be avoided in the ducting installation.

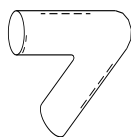

Severe bends

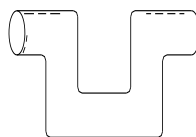

Multiple direction changes

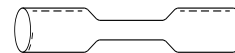

Multiple reducers/ crimped duct

# Installation Considerations

4. Excessive use of flex-duct and long flex-duct runs should be avoided.
5. Fire dampers must be fitted as per national and local fire regulations.
6. Unit must not be exposed to ambient temperature above 40°C and should not face an open fire.
7. Take action to avoid dew and frost.

As shown by drawing below, unit will produce dew or frost when saturation curve is formed from A to C. Use pre-heater to ensure conditions are kept to right of the curve (B to B'), to move C to C') to prevent condensation or frost formation.

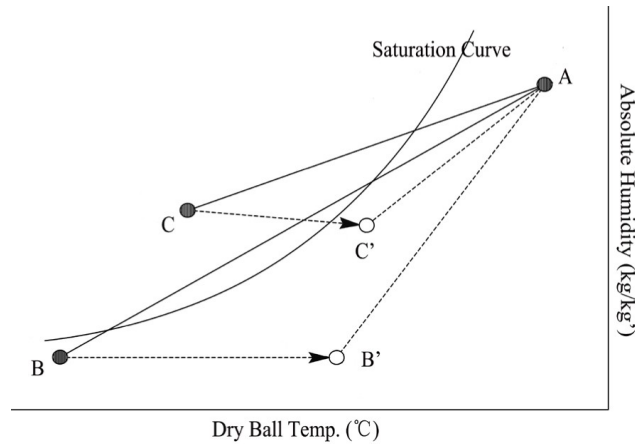

8. To avoid the outdoor exhaust air cycling back to indoor, the distance between the two vents installed on the outside wall should be over 1000mm.
9. If heater is equipped to the unit, operation of heater should be synchronous with the unit, so that the heater starts to work only when unit starts.
10. Duct muffler may be considered if user wants indoor noise to be minimized.

# Installation Considerations

## Installation Diagram

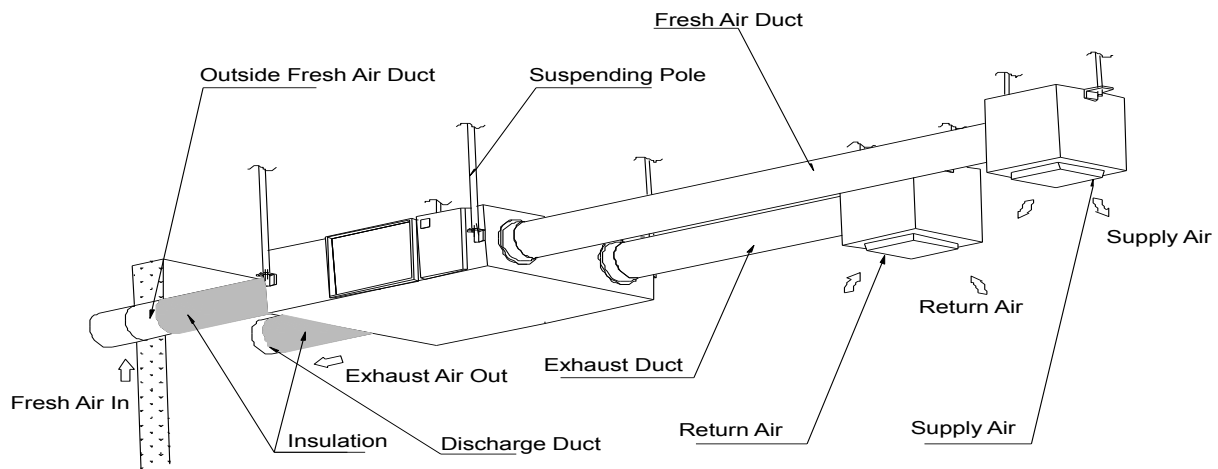

## Physical Installation

1. Installer to prepare suitable threaded hangers with adjustable nuts and gaskets.
2. Install as shown by the image above. Installation must be level and securely fastened.
3. Failure to observe proper fixing could result in injury, equipment damage and excessive vibration. Uneven installation will also effect damper operation.

Notes for reverse installation of the unit

4. Reverse labeling shows the unit is upside down.

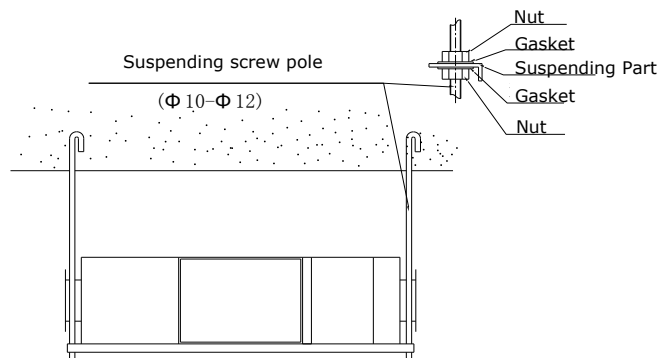

## Ducting

1. Connection of unit vents and ducts should be taped or sealed to prevent air leakage, and should comply to relevant guidelines and regulations.
2. The two outdoor vents should face downward toward the outside to prevent any rain water ingress. (angle 1/100 1/50).
3. Insulation must be with the two ducts outside to prevent condensation.

Material: glass cotton, Thickness: 25mm

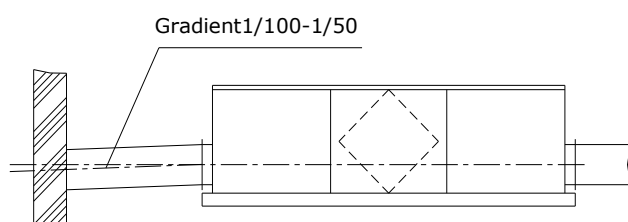

# Electrical Installation

## Warning

Power must be isolated during installation and before maintenance to avoid injury by electric shock. The specifications of cables must strictly match the requirements, otherwise it may cause performance failure and danger of electric shock or fire.

Power supply is AC220V/50HZ/1 Phase. Open the cover of electrical box, connect the 2 wires (L/N/) to the terminals and connect the cable of the control panel to the board according to the wiring diagram, and join the control panel to the cable.

Model	Spec. of power supply cable	Spec. of normal controller cable
XHBQ-D1.5DCTPA	2×1.5mm <sup>2</sup>	2×0.5mm <sup>2</sup>
XHBQ-D2.5DCTPA		
XHBQ-D3.5DCTPA		
XHBQ-D5DCTPA		
XHBQ-D6.5DCTPA		
XHBQ-D8DCTPA		
XHBQ-D10DCTPA		
XHBQ-D15DCTPA and D20DCTPA		

## Warning

We do not accept any liability for any problems caused by the user's self and non-authorized re-engineering to the electrical and control systems.

# Wiring Diagrams

## XHBQ-D1.5DCTPA to XHBQ-D10DCTPA

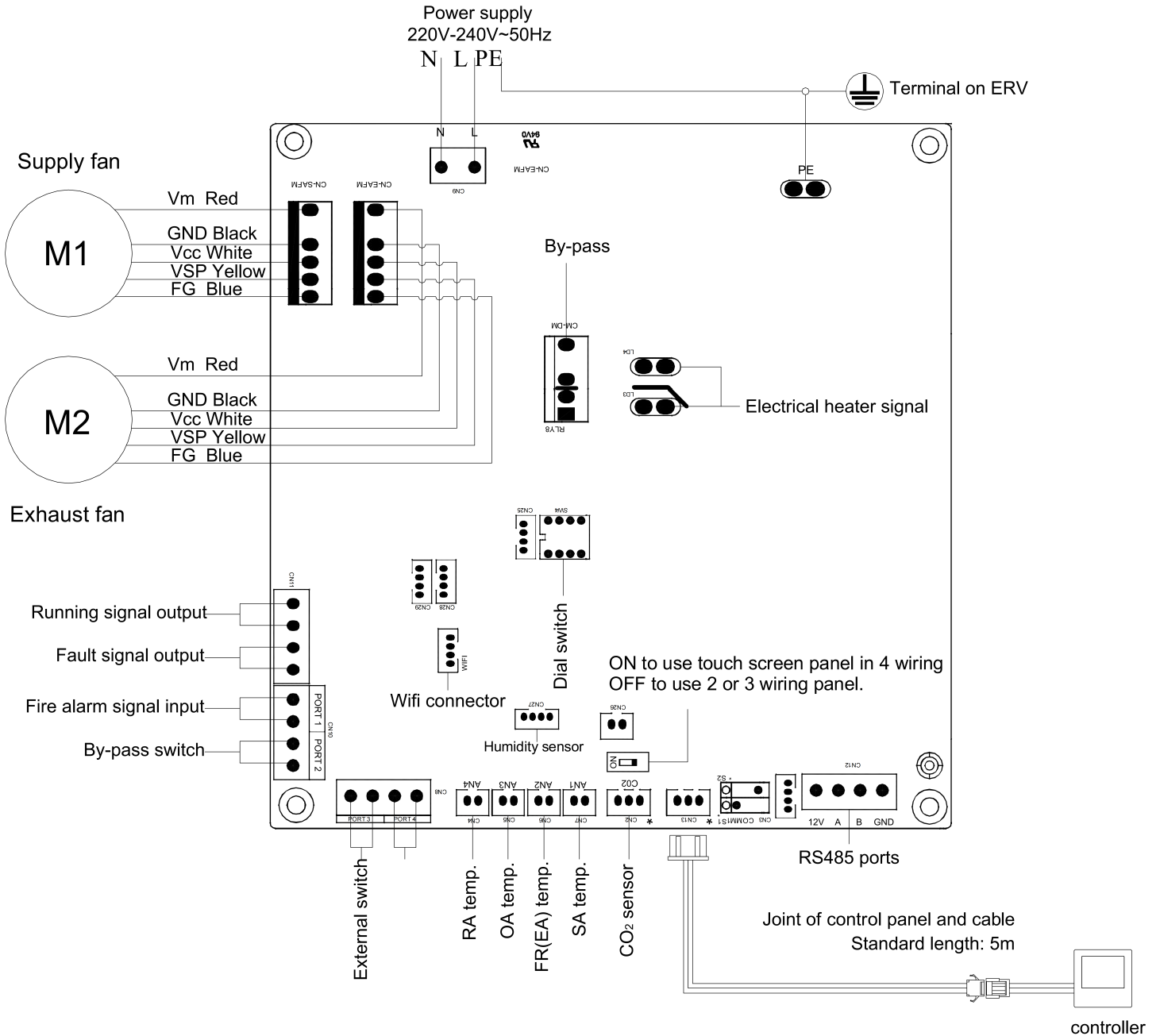

# Wiring Diagrams

## XHBQ-D15DCTPA to D20DCTPA Models

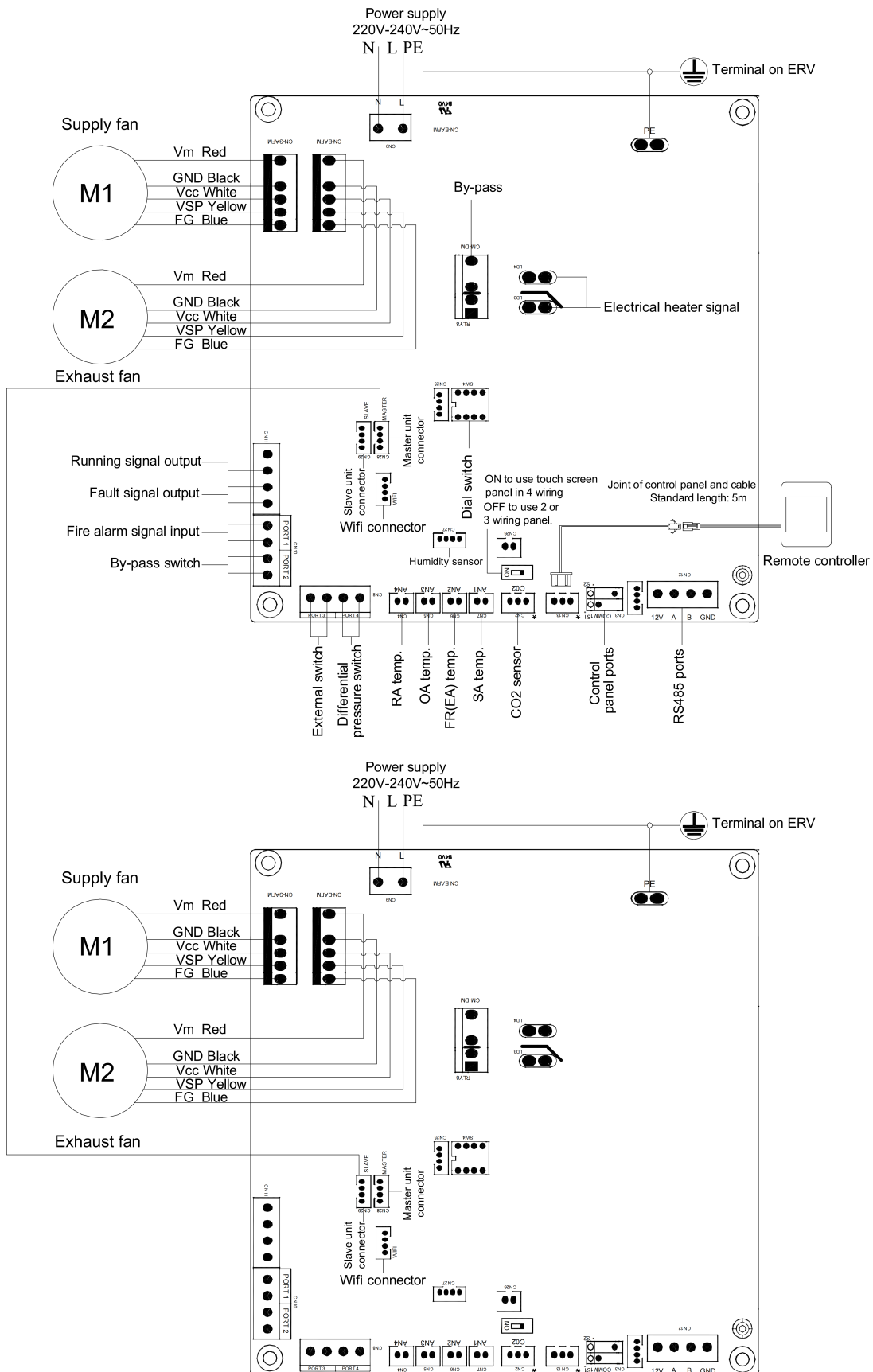

# Touch Screen Intelligent Controller

## Control Panel

The intelligent controller is surface mounted and comes with a touch screen LCD display screen. The standard connection cable is 5 meters, but you can prepare extra cable if necessary.

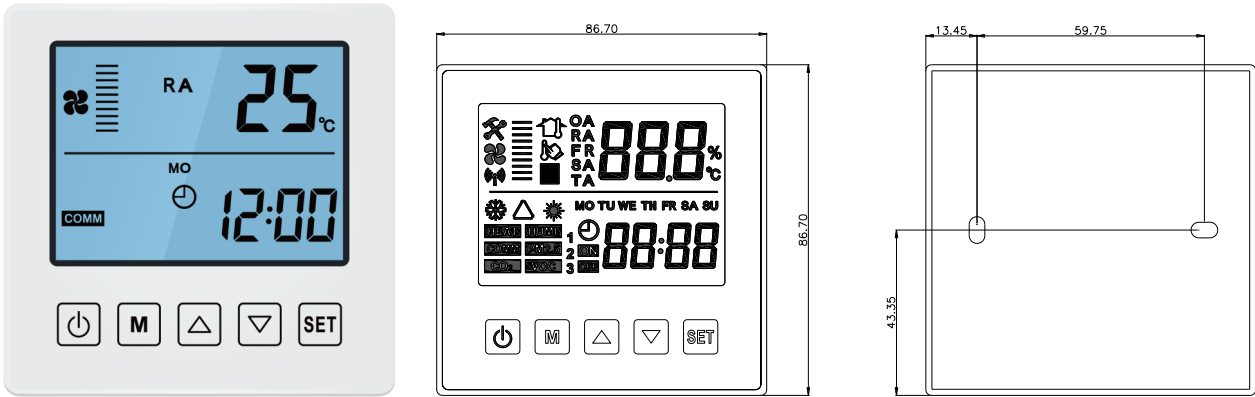

## Display screen and Buttons

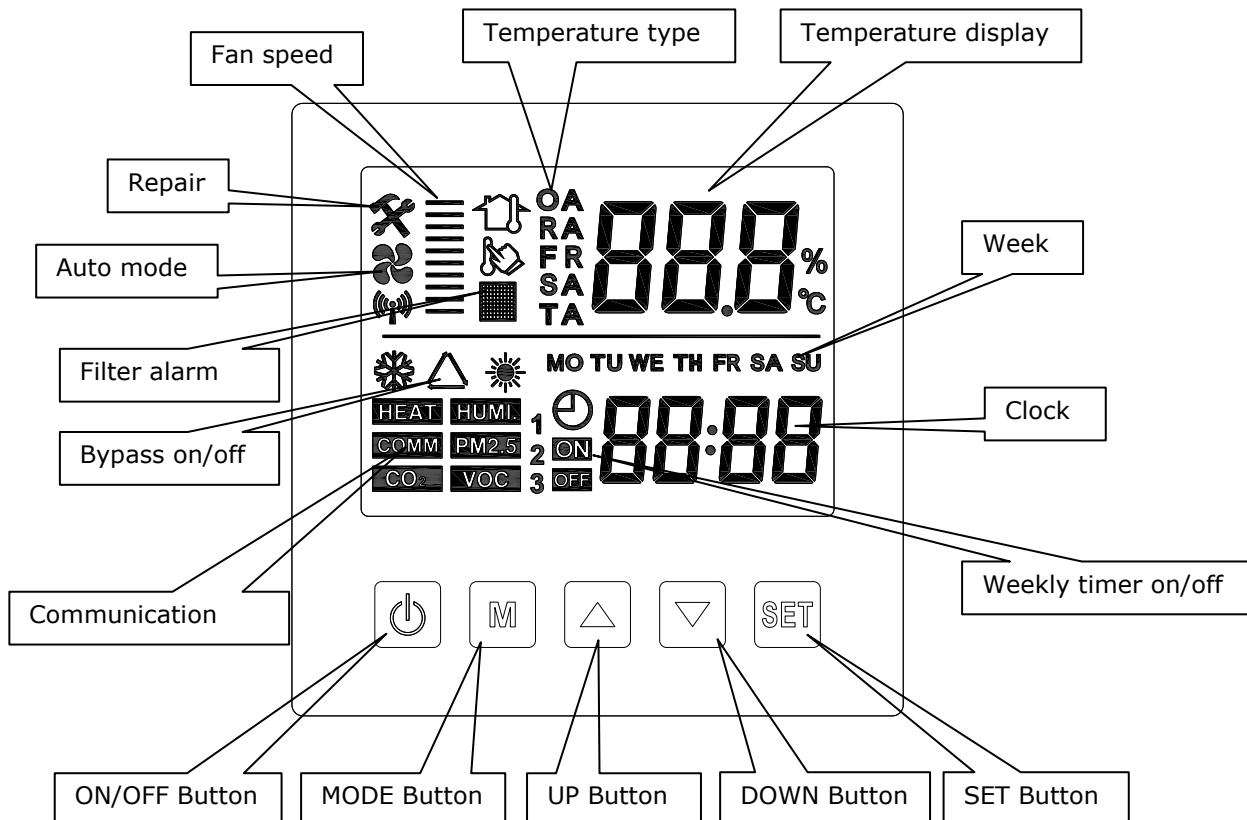

# Touch Screen Controller Instructions

## Operation Instructions

1. ON/OFF: press ON/OFF button once for starting; twice for closing. In ON status, backlit LCD display lights up, in OFF status, backlit LCD display off, without operation for 30 seconds, backlit LCD display off too. By pressing ON/OFF button for around 6 seconds can lock and unlock the controller.

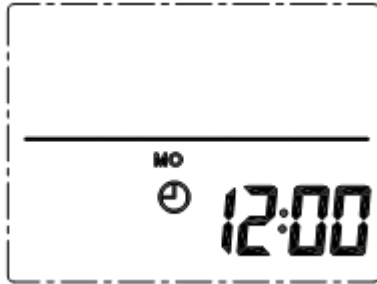

OFF state

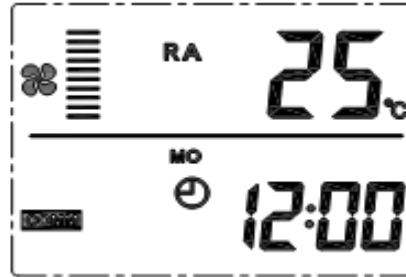

ON state

2. Mode switch: press MODE button to choose display the RA-OA-FR(EA)- SA Setting-CO2 status or Humidity control status.

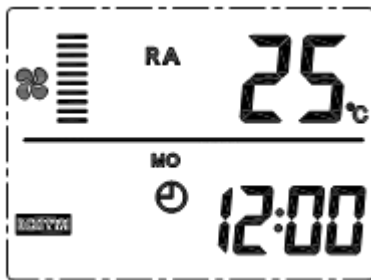

RA temperature

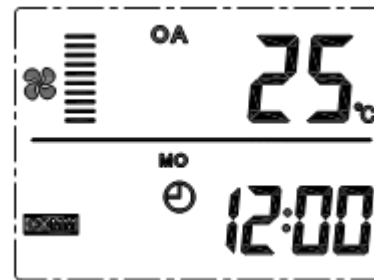

OA temperature

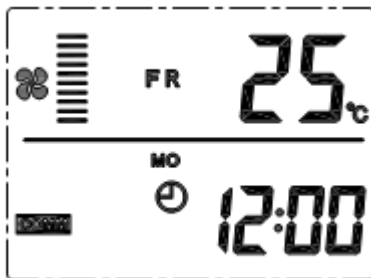

FR temperature

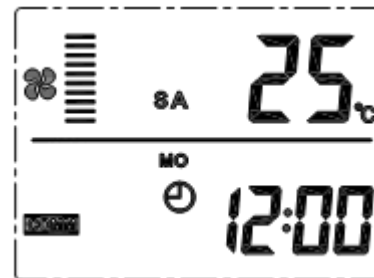

SA temperature

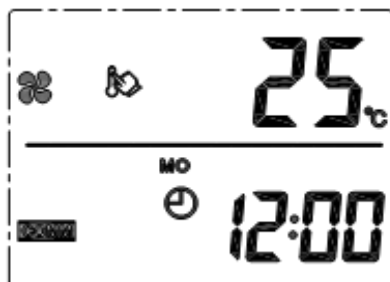

SA temperature setting

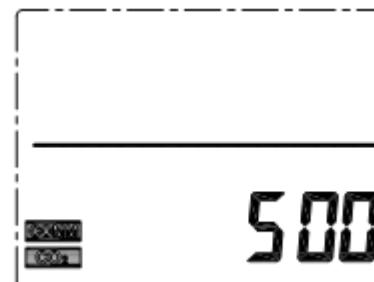

CO2 concentration



# Touch Screen Controller Instructions

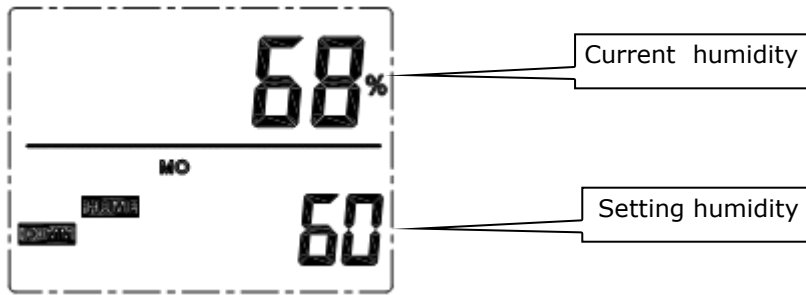

Humidity control

Remark:

1) Under SA setting mode, after connecting the electrical heater to the PCB (LD3 and LD4) and change parameter 01 to value 1, users can set the supply air temperature by pressing up and down button. The setting temperature range is 10-25°C.

A)  $0^{\circ}\text{C} < \text{setting temperature minus SA temperature} < 5^{\circ}\text{C}$ , 1st stage heater on, 2nd stage heater off

B)  $\text{Setting temperature minus SA temperature} > 5^{\circ}\text{C}$ , 1st and 2nd stage heater on

2) The CO2 symbol appears when the CO2 sensor is connected. ERV runs at boost speed when CO2 concentration higher than setting value.

3) The humidity symbol appears when the "temperature and humidity sensor" is connected. ERV runs at boost speed when humidity higher than setting value.

Under "humidity control" mode, users can set the setting humidity by pressing up and down button. The setting range is 45% ~ 90%. And the Dial switch SW4-3 on the PCB should be switched ON to switch from CO2 control function to humidity control function.

3. Air volume setting: Under SA or RA temperature interface. Users can set the return air volume in "RA" status, and set the supply air volume in "SA" status by pressing up and down button. Totally 3 speeds control.

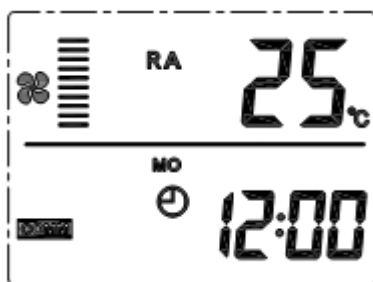

Low speed

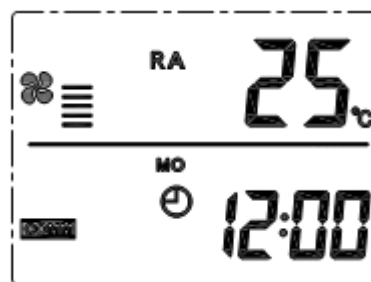

Middle speed

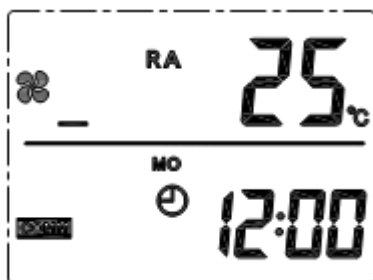

High speed

# Touch Screen Controller Instructions

4. Error code checking: under the main interface, press the SET button for short, user can check the error code of ventilator, refer to below table.

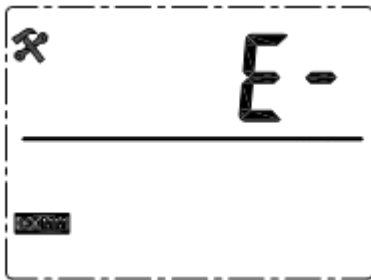

No Error

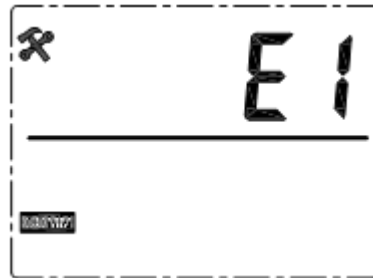

Error alarm

Code	Error
E1	Fresh air temperature sensor error
E2	EEPROM error
E3	Return air temperature sensor error
E4	Exhaust air temperature sensor error (defrosting temperature error)
E5	Communication error
E6	Reserved

5. Bypass setting: when bypass is on, the triangle bypass symbol appears, when bypass is off, the symbol disappears, please refer to page 15 commissioning part for the detailed setting introduction.



Bypass on

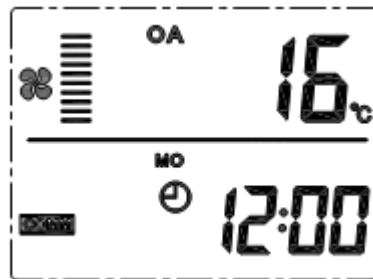

Bypass off

6. Filter alarm: When running time of ventilator is over the setting filter alarm time, the filter alarm symbol flashes to remind user clean/replace the air filters. After filters being cleaned/replaced, please sweep the filter alarm by setting parameter Number 24, value 1.

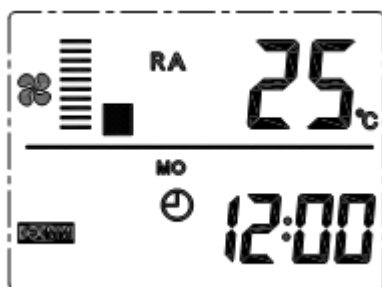

Filter alarm on

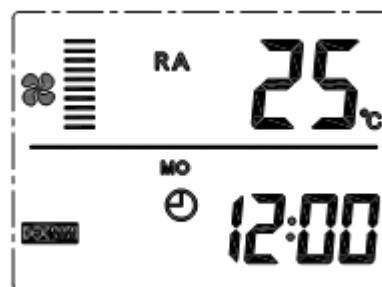

Filter alarm off

# Touch Screen Controller Instructions

7. Parameters setting: Keep pressing the MODE button for 6 seconds, after buzzing to enter the parameter setting interface.

After entering the parameter setting interface, press SET button shortly to change the parameter number, every pressing will make parameter value +1 (until number 25 then repeat again). After choosing the correct parameter number, press Mode button for short, parameter value flashes at the top right corner, at this time to change the value by UP and DOWN buttons. After parameters setting then press SET button to save.

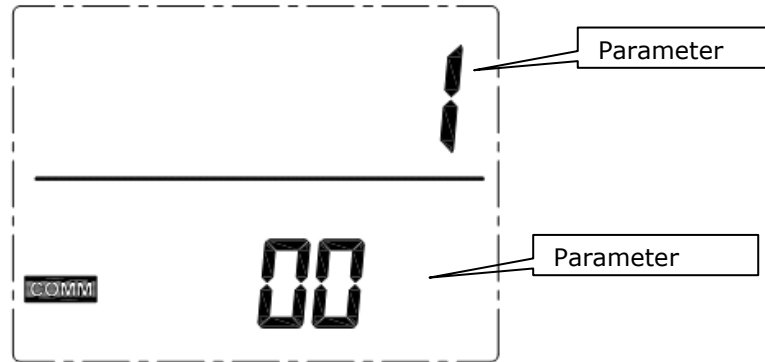

**Attention:**

- 1) After parameters setting, system need around 15 seconds to record, during this period power should not be off.
- 2) Please refer to below valid parameters table to set the suitable parameters according to different requests.

No.	Contents	Range	Default	Unit	Record Position
00	Power to auto restart	0-1	1		Main control
01	Electrical heater available	0-1	0		Main control
02	Bypass opening temperature X	5-30	19	°C	Main control
03	Bypass opening temperature range Y	2-15	3	°C	Main control
04	Defrost interval	15-99	30	Minute	Main control
05	Defrost entering temperature	-9-5	- 1	°C	Main control
06	Defrosting duration time	2-20	10	Minute	Main control
07	CO2 sensor function value	80-250	00	PPM	Main control
08	ModBus address	1-16	1		Main control
21	ERV models match/selection	0-7	0		Main control
23	Fan speed control	0=2 speeds 1=3 speeds 2=10 speeds (DC)	2		
24	Multifunction setting	0=Reserved 1=Sweep filter alarm 2=sweep weekly timer	0		
25	Filter alarm setting	0=45 days 1=60 days 2=90 days 3=180 days	0		Main control

# Touch Screen Controller Instructions

## Instruction of Parameter Settings

1) Parameter 00 refers to power to auto restart  
0: Invalid, 1: Valid

2) Parameter 01 refers to Supply air electrical heater function  
0: Not available 1: Available

When connecting with supply air electrical heater, user should choose 1 to activate the electrical heater, and under the SA temperature setting interface, the SA temperature can be set by pressing up and down button. The setting temperature range is 10-25°C.

3) Parameter 02-03 refers to automatic bypass function

The bypass is opened on the condition that the outdoor temperature is equal or higher than X (parameter 02) and less than X+Y (parameter 03). Bypass is closed on other conditions.

4) Parameter 04-06 refers to automatic defrost function

When EA side of heat exchanger temperature lower than  $-1\text{°C}$  (defrosting entering temperature, parameter 05) and last for 1 minute, and the interval of defrosting is longer than 30 minutes (parameter 04), the exhaust fan will run at high speed automatically for defrosting, and supply fan will stop, until EA side temperature higher than defrosting entering temperature  $+15\text{°C}$  for 1 minute, or the defrosting time is longer than 10 minutes (parameter 06).

5) Parameter 07 refers to CO2 concentration control function (optional)

After connecting the optional CO2 sensor, the CO2 symbol will display on the screen. If CO2 concentration is higher than setting value, then ERV runs at high speeds automatically, after CO2 concentration is lower than setting value, then ERV returns back to the previous status (standby, speed 1, 2, 3 etc.), if the ERV is already in highest speed when CO2 concentration higher than setting value, then ERV keeps the highest speed running. CO2 default setting value is 00, which means CO2 function off, setting range is 80-250, which means 800-2500PPM (setting value times 10), recommend PPM is 1000.

6) Parameter 08 refers to the central control function to identify the address of ERV.

7) Parameter 21 to match the suitable program on PCB to the ERV model, refer to below table.

Code	Models	Code	Models
6	XHBQ-D1.5DCTPA	1	XHBQ-D8DCTPA
5	XHBQ-D2.5DCTPA	2	XHBQ-D10DCTPA
4	XHBQ-D3.5DCTPA	1	XHBQ-D15DCTPA
3	XHBQ-D5DCTPA	2	XHBQ-D20DCTPA
0	XHBQ-D6.5DCTPA		

8) Parameter 23 refers to the fan speed display, for the ERV with BLDC motor, user should change value to 2 for 10 speed control.

9) Parameter 24 refers to clear filter alarm and weekly timer setting.

10) Parameter 25 refers to set the filter alarm timer.

# Touch Screen Controller Instructions

## 8. Time setting

Keep pressing the SET button for 6 seconds, after buzzing to enter the time setting interface. Under this interface, press the MODE button shortly, then can switch from time setting, day setting, weekly timer on and weekly timer off setting.



Time setting



Week setting

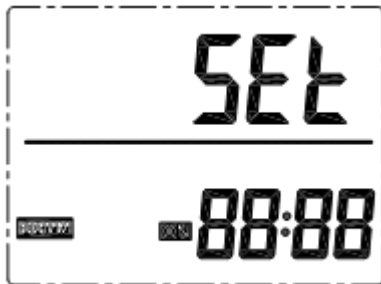

Weekly timer on

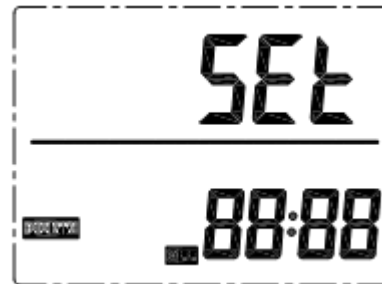

Weekly timer off

A. Time setting: under time setting interface, press SET button for short, at this time "hour" flashes, press UP and DOWN button to change "hour". After setting "hour", press MODE button for short to switch to "minute" setting, at this time "minute" flashes, press Up and Down button to change "minute". After time setting, press SET button to save and return to the main interface.

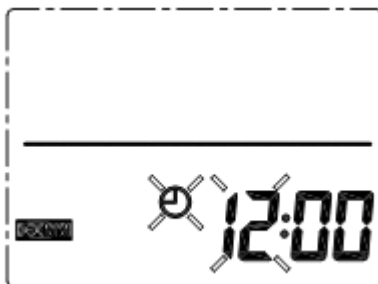

Hour setting

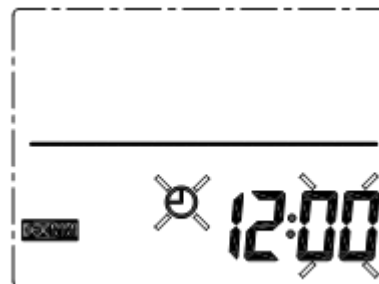

Minute setting

# Touch Screen Controller Instructions

B. Day setting: under day setting interface, press SET button for short to begin the day setting, by pressing UP and DOWN buttons to select the correct day, after this finished, press SET button to save and return to the main interface.

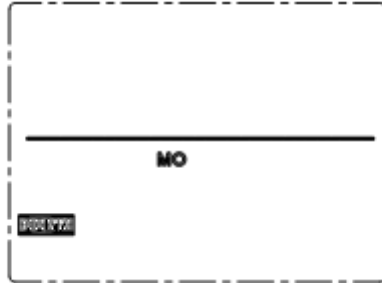

C. Weekly timer on setting: under weekly timer on setting interface, press SET button to begin the timer on setting, press SET button time after time to select Monday period 1 to Sunday period 2 (namely Monday period 1 to Sunday period 2).

After selecting the day, press ON/OFF button to confirm timer on is valid/invalid.

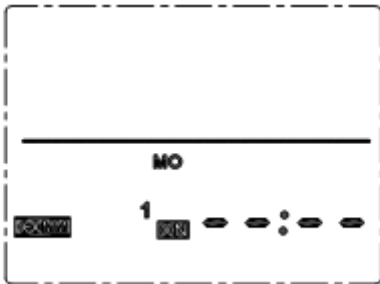

Period 1 timer on

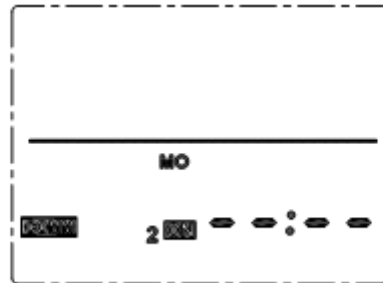

Period 2 timer on

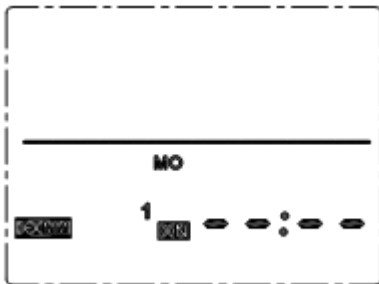

Timer on valid



Timer on invalid

When timer on is valid, press MODE button to enter "hour" setting, by pressing UP and DOWN button to set "hour". After "hour" setting, press MODE button to enter "minute" setting. After "minute" setting, press SET button to save and switch to the next day timer on setting, and repeat the above steps to set all days and periods timer on. After setting all the time on, press SET button to save the data.

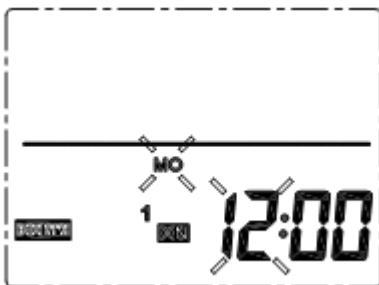

Timer on hour setting

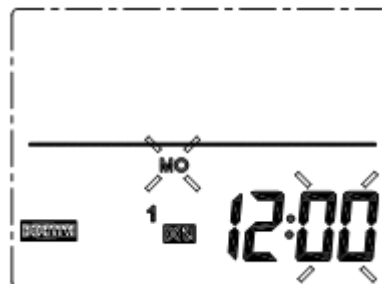

Timer on minute setting

# Touch Screen Controller Instructions

D. Weekly timer off setting: under weekly timer off setting interface, press SET button for short to begin the timer off setting, press SET button time after time to select Monday period 1 to Sunday period 2 (namely Monday period 1 to Sunday period 1 then Monday period 2 to Sunday period 2).

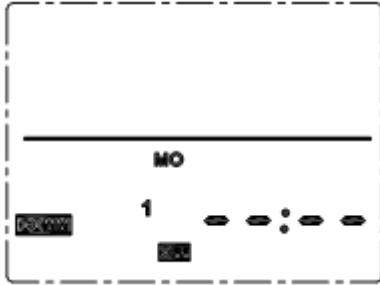

Period 1 timer off

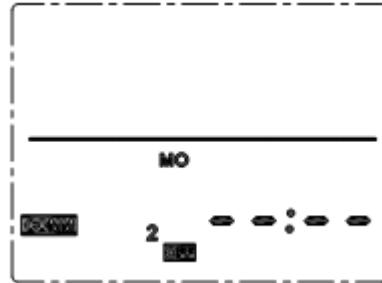

Period 2 timer off

Under the week interface, press ON/OFF button to confirm the timer off is valid/invalid.

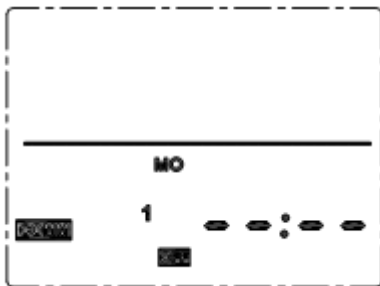

Timer off invalid

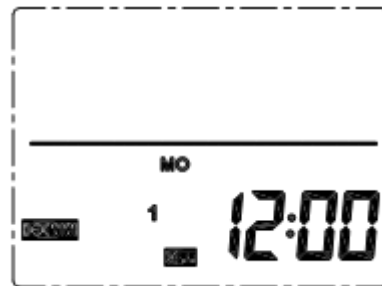

Timer off valid

When timer off is valid, press MODE button to enter "hour" setting, by pressing Up and Down button to set "hour", after "hour" setting, press MODE button to enter "minute" setting, after "minute" setting, press SET button to save and switch to the next day timer off setting and repeat the above steps to set all days and periods timer off. After setting all the timer off, press SET button to save the data.

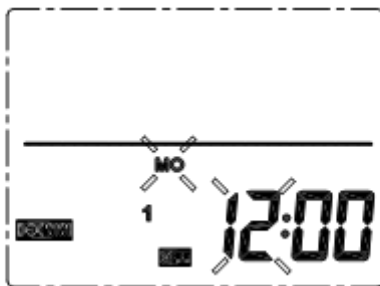

Timer off hour setting



Timer off minute setting

Attention: Under time setting, if no operation for 10 seconds, system will return to the main interface automatically.

# Touch Screen Controller Instructions

9. Defrosting: When the ventilator is under defrosting, the defrosting symbol will show as below.

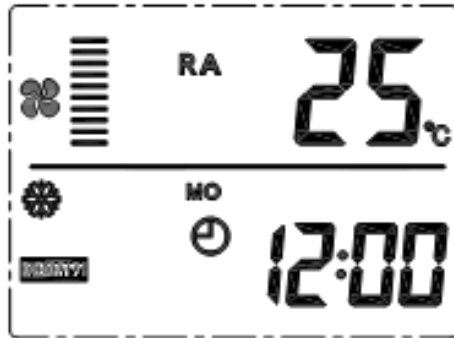

## 10. Humidity control (optional function)

In "humidity control" status, users can set the setting humidity by pressing up and down button. The setting range is 45% ~ 90%.

In off status, current humidity is higher than setting humidity, the ventilator turns on and runs at high speed automatically. At that time, if current humidity is lower than setting humidity, the ventilator turns off.

In on status, current humidity is higher than setting humidity, the ventilator runs at high speed, if the current running status is high speed, then the unit keep the current status. At that time, if current humidity is lower than setting humidity, the ventilator returns the running status before.



# ModBus Address

Parameter No.	Content	Range	Default	Record Position
00	Useless			Main control
01	Useless			Main control
02	Bypass opening temperature X	5-30	19	Main control
03	Bypass opening temperature range Y	2-15	3	Main control
04	Defrosting interval	15-99	30	Main control
05	Defrosting enter temperature	-9-5	-1	Main control
06	Defrost duration time	2-20	10	Main control
07	CO2 sensor	28-C8 (392-1960ppm)	66 (1000ppm)	Main control
08	ModBus address	1-		Main control
09	ERV ON/OFF	0-OFF 1-ON		Main control
10	Supply fan speed	Fan speed: 0=stop, 2=speed 1, 3=speed 2, 5=speed 3, 8=speed 4, 9=speed 5, 10=speed 6, 11=speed 7, 12=speed 8, 13=speed 9, 14= speed 10		Main control
11	Exhaust fan speed	Fan speed: 0=stop, 2=speed 1, 3=speed 2, 5=speed 3, 8=speed 4, 9=speed 5, 10=speed 6, 11=speed 7, 12=speed 8, 13=speed 9, 14= speed 10		Main control
12	Room temperature	observed value		Main control
13	Outdoor temperature	observed value		Main control
14	Exhaust air temperature	observed value		Main control
15	Defrosting temperature	observed value		Main control
16	External ON/OFF signal	query value		Main control
17	CO2 ON/OFF signal	query value		Main control
18	Fire alarm signal/bypass/defrosting signal	query value: B0 - 1-fire alarm ON B1- 1-bypass on B2- 1-bypass off B3- 1- defrosting		Main control
19	Electrical heater stage			Main control
20	Error symbol	query value: B2-OA temperature error B5-EEPROM error B4-RA temperature error B3-Fr temperature error ( auto defrosting)		Main control
21	ERV models selection			
22	Defrosting models			

# Introduction of dial switch

## Introduction of dial switch

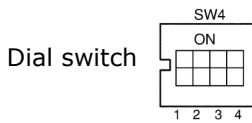

- 1. SW4-1: OFF-Traditional EA fan defrost      ON-OA side electrical heater defrost**
- 2. SW4-2: OFF-Auto by-pass and manual bypass via voltage free connector (free cooling)**
- 3. SW4-3: OFF-CO2 sensor                              ON-Humidity and temperature sensor**
- 4. SW4-4: Reserve**

**Attention: Please cut off the power before dialing.**

1. SW4-1 is switching the defrost mode. Default is "off", it means traditional defrost by EA fan. When turn to "on", the defrost mode is changed to be OA side heater defrost (required to connect the heater to the OA duct, only suggested in winter under  $-15^{\circ}\text{C}$ ), at this time the parameter 01 would be turned to 0 automatically and the supply air side electrical heater is not able to use.

Under electrical heater defrost mode, controller can automatic drive the electric heater on/off to heat the fresh air in order to prevent frosting at the EA side of heat exchanger.

- 1) If the outdoor fresh air temperature  $< -15^{\circ}\text{C}$ , the OA heater turns on for 50 minutes, then the ventilator switches off for 10 minutes and restarts.
- 2) If the OA heater switches on and the exhaust air temperature still  $< -1^{\circ}\text{C}$ , then the ventilator will stops for 50 minutes.
- 3) If the exhaust air temperature  $< -1^{\circ}\text{C}$  and the outdoor air temperature  $> -15^{\circ}\text{C}$ , the OA heater switches on for 10 minutes for defrosting.
- 4) If the OA heater is on and temperature of outdoor air is  $> +25^{\circ}\text{C}$ , then OA heater will stop for 5 minutes, If the outdoor air temperature is detected over  $25^{\circ}\text{C}$  by sensor over 3 times, electrical heater stops.

2. SW4-2 is the by-pass mode. Default is "off", it means that by-pass will open automatically based on the outdoor temperature. After connecting the bypass free voltage connector (refer to the wiring diagram), then bypass damper opens manually and fans run at high speed.

3. SW4-3 is switching the forced ventilation mode. Default is "off", it means that ventilator is controlled by  $\text{CO}_2$  sensor. When turn to "on", the ventilator is controlled by humidity sensor and  $\text{CO}_2$  sensor. if SW4-3 turn to "ON" but without connecting humidity sensor, then E3 error happen.

4. SW4-4 is reserved.

### External ON/OFF switch control logic

External switch can receive voltage free signal to control the ventilator on or off.

-Ventilator off, when ventilator have external on signal, ventilator run at high speed, when ventilator have external off signal, ventilator return back to off.

- Ventilator on, when ventilator have external on signal, ventilator run at high speed, when ventilator have external off signal, ventilator return back to previous fan speed

# Maintenance

## Warning

Power must be isolated before installation and maintenance to avoid injury or electric shock. Supply power cables, main circuit breaker and earth leakage protection, must comply with national regulations. Failure to observe could cause unit failure, electric shock or fire.

Standard filtration is supplied with this unit and must be used. Dust and dirt can accumulate in the heat exchanger if filters are removed. (This can lead to failure or decreased performance). To ensure efficient operation, regular cleaning or replacement of filters is required. Filter maintenance frequency will depend on working environment and unit running time.

### Cleaning the filter

1. Open the access door
2. Remove the filters (from the side of the unit)
3. Vacuum the filters to get rid of the dust and dirt. For bad conditions dip it into water with soft wash to clean.
4. Push the filters to the positions after they get dried naturally, close the access door.
5. Change the filters if they are badly affected with dust and dirt or if they are broken.

### Maintenance of heat exchanger

1. Pull off the filters first
2. Draw out the exchanger from the unit
3. Establish a cleaner schedule to clean the dust and dirt on the exchanger.
4. Install the exchanger and filters to their positions and close the access door.

Remarks: It is recommended maintenance of the exchanger is made every 3 years

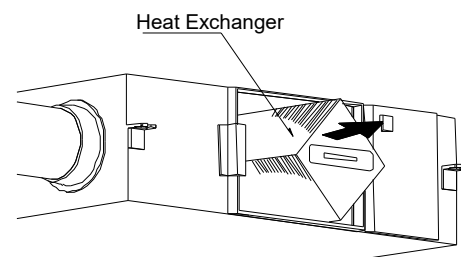
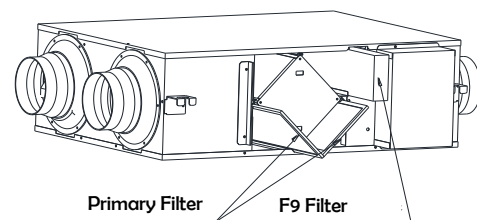
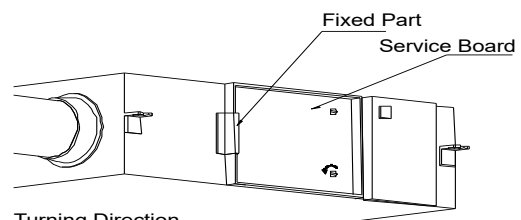

### Failure diagnose

User can use the unit after trial operation. Before contacting us, you can make self trouble shooting following below chart in case of any failure.

Phenomenon	Possible reason	Solutions
The airflow volumes both indoor and outdoor vents drop obviously after a period of operation.	Dust and dirt blocking the filter	Replace or clean the filter
Noise comes from vents	Vents installation are losing.	Re-tightening the vents connections
Unit doesn't work	1. No electricity 2. Protection breaker is cut	1. Guarantee power is on 2. Connect the breaker



**KAFFE S.A. VENTILATION CENTER**  
Siteia 6, 144 51 Metamorfori, ATHENS- GREECE  
Tel: +30 210 2850573 Fax: +30 210 2849028